



INFLATABLE HIGH JUMP & POLE VAULT LANDING SYSTEMS!

Delivers world-class landing systems without the storage issues or headaches of using traditional foam pits! Safe and affordable landing systems that provide athletes and athletic departments alike flexible and usable systems to maximize their jumping results! The landing systems are quickly deflated and stored with the onset of inclement weather!

INFLATE & GO is so easy to Use
— It'll Blow You Away

A INFLATABLE HIGH JUMP LANDING SYSTEM

- Stores in a small, convenient 33-1/2" w x 64-1/2" L x 25" D weather resistant case, in 1/5th of the space needed to store a traditional high jump foam landing pit.



EASILY INFLATES AND ASSEMBLES BY 1-PERSON!



SAFER 1-PIECE UNIT!



MAXIMIZES YOUR JUMPING RESULTS!



CONVENIENTLY STORES IN 1/5TH OF THE SPACE!

- 1-piece landing unit eliminates the risk of injury due to falling between gaps.
- Simple assembly and disassembly can be completed easily by one person.

B INFLATABLE POLE VAULT LANDING SYSTEM

- 1-piece air unit stores in a 46" w x 65" L x 34" D aluminum portable storage, weather resistant case.
- Pole vault pit is designed with stainless steel hardware.
- 10' L x 6' w foam collar that fits snug around vault box.

MEETS
NCAA®
NFHS IAAF
RULES

*The End to
PV Storage
Problems!*



CUT AWAY WITH FULL EXTENSION!

For more information and to view a video visit our website at www.blazerathletic.com.

ALL BLAZER HURDLES SHIP FULLY ASSEMBLED ★ WITH 5-YEAR WARRANTY!

C
1134

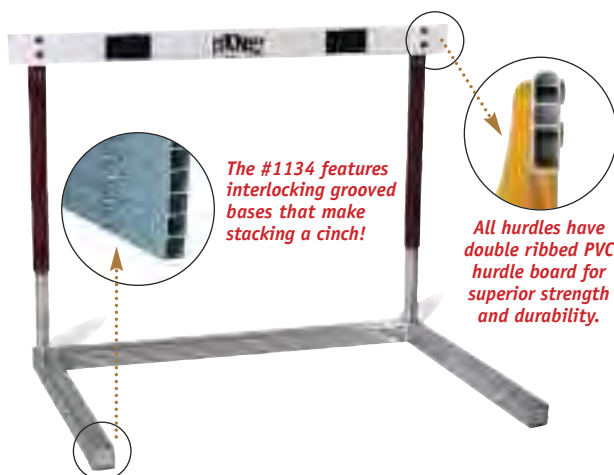

The #1134 features interlocking grooved bases that make stacking a cinch!

All hurdles have double ribbed PVC hurdle board for superior strength and durability.

C High School Elite Aluminum Hurdle

Welded one-piece aluminum base with exclusive, built-in, interlocking guides for easy stacking.



1134 23 LBS. FREIGHT ONLY
Meets IAAF regulations

CONTACT DEALER FOR PRICING

D
1148



D High School Rocker Hurdle
Steel base and aluminum upright.

1148 25 LBS.
FREIGHT ONLY

CONTACT DEALER FOR PRICING

ALL HURDLES IN STOCK & READY TO SHIP!
We are waiting on YOU!

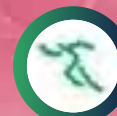

TRACK & FIELD
PGS 4-27

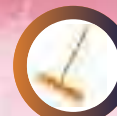

FIELD MAINTENANCE
PGS 28 & 37



VOLLEYBALL
PGS 29-35



BASEBALL & SOFTBALL
PGS 36-37



FOOTBALL
PGS 38-39



TRAINING
PGS 40-43



SOCCER
PG 44

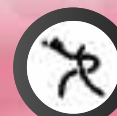

BALL RACKS
PG 45



SCOREBOOKS & LINE-UP CARDS
PGS 46-47



★ ALL BLAZER HURDLES SHIP FULLY ASSEMBLED ★ 5-YEAR WARRANTY ★

A
1138

One of the Greatest Hurdles Ever Built!

All hurdles have double ribbed PVC hurdle board for superior strength and durability.

The #1138 features interlocking grooved bases that make stacking a cinch!

#1138 features adjustable weight settings.

MEETS IAAF REGULATIONS

A Aluminum College Hurdle

Spring loaded, slide weight adjustments in base. Welded one-piece aluminum base. Exclusive, built-in, interlocking guides for easy stacking. 47" board available for IAAF regulations. (Additional charges may apply.)

1138 29 LBS. FREIGHT ONLY

CONTACT DEALER FOR PRICING

B
1136



B Aluminum College Hurdle

With adjustable sliding base weights.

1136 28 LBS. FREIGHT ONLY

CONTACT DEALER FOR PRICING

STORE HURDLES UPRIGHT!
NOT ON THEIR SIDE TO PREVENT DAMAGE.

C
1163



C Plastic Replacement Hurdle Board

Double ribbed PVC board only.

1163D \$23.00

Drilled Replacement Hurdle Board for Blazer Base
UPS SHIPPABLE 1.6 LBS.

1163U \$23.00

Undrilled Replacement Hurdle Board
UPS SHIPPABLE 1.6 LBS.



Select 1 -or- 2 Colors for Your Hurdle Gate Tubes at NO ADDITIONAL CHARGE!

Upright tubing on all hurdles, except the #1090, #1095 and #1100 have a variety of Available Colors: Natural Aluminum (standard color), Navy, Orange, Maroon, Royal, Purple, Red, Green, Light Gold, Black, Vegas Gold and White.

Screening also available on reverse side of board. Contact your local dealer for all the details.



ALL BLAZER HURDLES MEET H.S. PULLOVER SPECIFICATIONS FOR ALL HEIGHTS AND H.S. FEDERATION RULES. ALL HAVE 5-HEIGHT ADJUSTMENTS 30"-33"-36"-39" AND -42".

Blazer can modify most hurdles on these pages to accommodate 36" lanes. Except for #1158 and #1178. Give us a call for details.

D
2722



TILTS ONTO ITS WHEELS!

D Two-Wheel Hurdle Cart

Place hurdles in a stack of up to 10 on the track. Steel construction with two-pneumatic wheels.

2722 \$399.00

UPS SHIPPABLE 55 LBS.

E
2723



E Hurdle Dolly

Steel construction. 4 heavy-duty swivel casters for ease of steering. For open base hurdles.

2723 UPS SHIPPABLE 31 LBS. \$290.00

HURDLE CART SELECTION CHART

	HURDLE CARTS	2700	2720	2722	2723	2724
HURDLES PER CART						
1132 ★ 1134 ★ 1136 ★ 1138 ★ 1140 ★ 1142	40 EA	20 EA	10 EA	10 EA	16 EA	
1148 ★ 1158 ★ 1168 ★ 1178	40 EA	25 EA	10 EA	N/A	N/A	



★ ALL BLAZER HURDLES SHIP FULLY ASSEMBLED ★ 5-YEAR WARRANTY ★

F
1158
1178

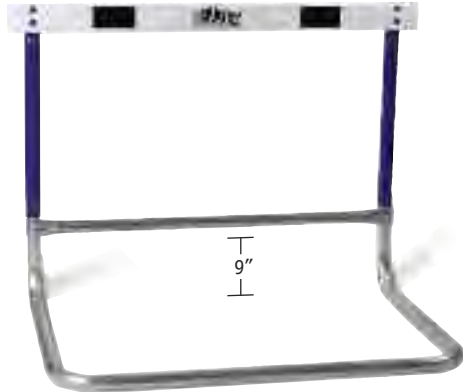

F High School Rocker Hurdle With Brace
High School Rocker Hurdle with brace for added stability.
 🇺🇸 **1158** 24 LBS. FREIGHT ONLY **CONTACT DEALER FOR PRICING**
All aluminum one-piece base - *With steel brace*
 🇺🇸 **1178** 29 LBS. FREIGHT ONLY **CONTACT DEALER FOR PRICING**
Steel base and aluminum upright - *With steel brace*

G
1148
1168



G High School Rocker Hurdle
High School Rocker Hurdle.
 🇺🇸 **1148** 25 LBS. FREIGHT ONLY **CONTACT DEALER FOR PRICING**
Steel base and aluminum upright
 🇺🇸 **1168** 21 LBS. FREIGHT ONLY **CONTACT DEALER FOR PRICING**
All aluminum one-piece base

ALL HURDLES IN STOCK & READY TO SHIP!
We are waiting on YOU!

H
1142



H Aluminum Open Base Rocker Hurdle
Welded one piece base.
The Hurdle Dolly, #2723 is not recommended with this hurdle.
 🇺🇸 **1142** 23 LBS. FREIGHT ONLY **CONTACT DEALER FOR PRICING**

I
1140



I Steel/Aluminum Open Base High School Rocker Hurdle
Easy carrying. Also works great for plyometric drills.
 🇺🇸 **1140** 31 LBS. FREIGHT ONLY **CONTACT DEALER FOR PRICING**

J
2724



J "L" Hurdle Cart
Steel construction. Wheels at handle end swivel. Walk in loading for easy stack ability. For open base hurdles. 41" w.
 🇺🇸 **2724** 78 LBS. FREIGHT ONLY **\$500.00**

K
2720

★ HOLDS 20-25 HURDLES! ★



K Universal Hurdle Cart
Strong steel construction. 8" cushion wheels for easy handling. Wheels at handle end swivel. Walk in loading for easy stack ability. 41" w.
 🇺🇸 **2720** 180 LBS. FREIGHT ONLY **\$600.00**



Made in USA

★ ALL BLAZER HURDLES SHIP FULLY ASSEMBLED ★ 5-YEAR WARRANTY ★

A
1100

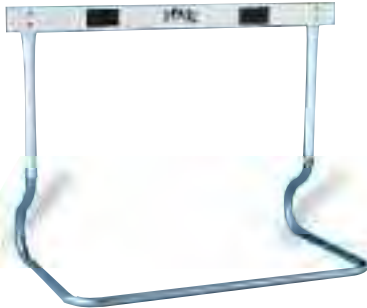

A Steel Practice Hurdle
4-height adjustments, 30"-33"-36"-39". Great practice hurdle. Plastic crossbar, does not meet pullover specs. Available with white gate tubes only.

1100 \$68.00
14 LBS. FREIGHT ONLY

B
1095



B Steel Elementary Adjustable Hurdle
Adjustable, 21"-24"-27" & -30". Plastic board. 41" width. Great learning hurdle. Available with white gate tubes only.

1095 \$72.00
14 LBS. FREIGHT ONLY

C
1090



C Steel Elementary Hurdle
Plastic crossbar. Stands 22" h x 41" w. (regulation width). Great hurdle for the beginner.

1090 \$55.00
10 LBS. FREIGHT ONLY

D
1167



D X-Trainer, Collapsible
Quickly adjusts from 16" to 39" h. Great training hurdle for plyometrics, speed, and agility drills. Inexpensive for beginners or a personal hurdle for yourself. Folds flat for easy transport and storage.

1167 \$40.00
UPS SHIPPABLE 5 LBS.



E
1169

Height Adjustments
30" & 39"

E Form Finder - Self Training Device

Forces the hurdler into correct body position. Keeps hurdlers arm movement in. Makes hurdler bring trail leg under armpit. Self-training allows coach to spend time with other events. Cloth cross-brace is Velcro® attached which breaks away easily upon contact by hurdler. Uprights are steel powder coated.

1169 With Hurdle Base \$150.00
UPS SHIPPABLE 2-PKGS - 1@ 21 LBS., 1@ 12 LBS.

F
1079



F Foam Hurdle Guard
This soft foam guard simply slips over the top of your hurdle gate. Perfect for preventing bruising and building confidence in your hurdler.

1079 \$10.20/ea
UPS SHIPPABLE 1 LB.

G
1080



G Indoor/Outdoor Foam Hurdle
30", 33", 36" & 39" adjustments. Made of 18-oz. vinyl coated nylon. Double Velcro® strips hold heights in place. The nylon cover is Velcro® attached.

1080 \$150.00
UPS SHIPPABLE 13 LBS.

Please contact your dealer for your final price.

POLE VAULT STANDARDS **BLAZER**

TRACK & FIELD

★ MEETS ALL H.S. FEDERATION ★ NCAA, IAAF RULES & REGULATIONS. ★

H
1189

H Collegiate Pole Vault Standard

Lightweight standard with powder coated black finish, anodized aluminum uprights and steel base for stability. 2.5"Ø x 5.5"w. Aluminum uprights adjust from 8'6" to 21'. Heights in English and metric. The telescoping riser is marked in 6" increments. 72"L x 24"w Steel base with anchoring points. Base adjusts from 0-32".

1189 \$2,300.00/pr

439 LBS. / PR. 4-BOXES FREIGHT ONLY

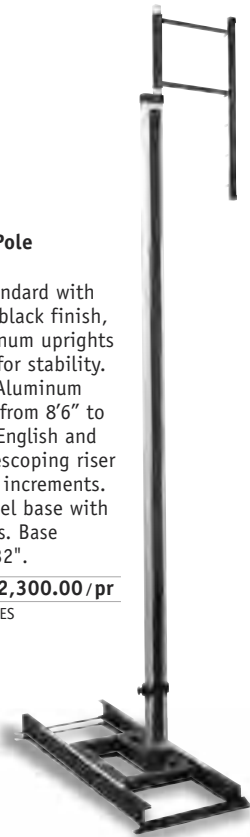

I
1188

I Cantabrian International PV Standard

New International/Collegiate design standards offer the ultimate in design and all aluminum lightweight materials. These high quality standards use large diameter aluminum extrusions for uprights to ensure the standards have the rigidity and durability needed for running top quality meets. "Boxed" aluminum designed offset risers with cross-braced welded design gives added crossbar stability. Sleek design aluminum bases adjust from 0-32"/80M. Adjusts from 8' 6" to 21' in both standard and metric. Crossbar pins are every 6" for quick easy adjustment of crossbar height.

1188 \$2,995.00/pr

305 LBS. / PR. 4-BOXES FREIGHT ONLY

NEW!

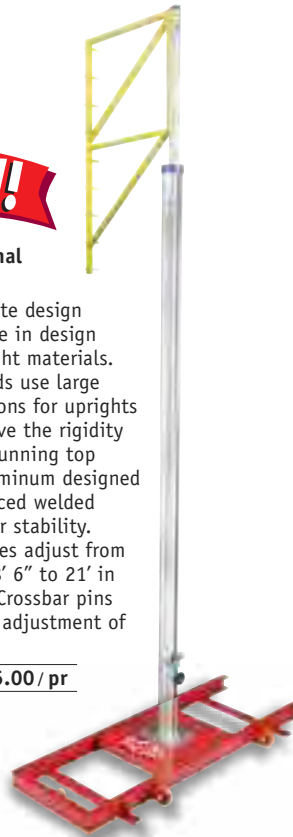

J
1198

J Pole Vault Standard Anchor Pins

Pins secure pole vault standards to the ground as required by NFH rule 7-5-11.

1198 \$27.00

Sold in sets of 8



ALL BLAZER STANDARDS ARE POWDER COATED!

K
1190

K Aluminum Adjustable Base Vault Standard

All aluminum powder-coated silver for the "new" appearance for years. Upright adjusts from 8'6" to 19' in 1/2" increments. Heights in English & metric. Features easy adjusting base with 32" of movement. Aluminum base is numbered in 1" increments.

1190 \$1,640.00/pr

118 LBS. / PR. 3-BOXES - FREIGHT ONLY

3" WIDTH FOR GREATER STABILITY!

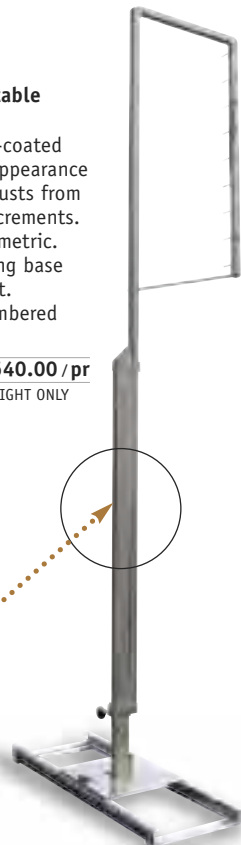

L
1195

L Steel Adjustable Base Vault Standard

Features the #1190 aluminum upright with the adjustable steel base of the #1183.

1195 \$1,414.00/pr

146 LBS. / PR. FREIGHT ONLY



M
1183

M Steel Adjustable Base Vault Standard

Features an easy adjusting base with 32" of movement. Base is numbered in 1" increments. Heights are measured in inches. Height adjustments from 5' to 18'. Easily disassembled for storage or base interchanging. Extra bases available.

1183 \$832.00/pr

144 LBS. / PR. - FREIGHT ONLY



A
1560 **A Crossbar Lifter**
For faster crossbar positioning.
All steel construction.
1560 **\$28.00**
UPS SHIPPABLE 3 LBS. + AH



B
1561 **★ SLIDES OVER CROSSBAR ★
OR POLE VAULT!**

B Deluxe Crossbar Center Lifter
This all-steel lifter addresses the need for only one person to put up a crossbar.

1561 UPS SHIPPABLE 3 LBS. **\$60.00**



C
8230 **Olympic Pole Vault Base Pads**
Only needed with the 32" height pits, #8205 and #8215. Olympic base pads to match the slope of the pit. Made with a wood base frame and high density foam, covered in 18oz. vinyl.



8230 FREIGHT ONLY **CONTACT DEALER FOR PRICING**
OVERALL SIZE: 66"L x 30"W x 32"H SLOPED TO 14"
* PLEASE NOTE COLOR CHOICE BEHIND STOCK # WHEN ORDERING.
SEE LIST BELOW FOR AVAILABLE COLORS.

D Pole Vault Standard Base Pads
Standard Base Pads are 4" of high density foam covered with 18 oz. vinyl. Pads are placed right on top of the standard base. These pads work with both inline and offset standard uprights.

8231 FREIGHT ONLY **\$850.00**
OVERALL SIZE: 66"L x 24"W x 4"H
* PLEASE NOTE COLOR CHOICE BEHIND STOCK # WHEN ORDERING.
SEE CHART BELOW FOR AVAILABLE COLORS.



E
1276 **★ PAD EASILY FOLDS IN HALF! ★**

NEW!

E Pole Vault Box Collar System
Fits any pole vault landing system. The cover is made of heavy duty vinyl, with polyethylene foam filler tested to meet new ASTM F-2949-12 specification. The system comes with four (4) in ground anchors (included), which limits shifting of landing area. A special hinge system allows the pad to fold in half to ship UPS and for easy storage.

1276 UPS SHIPPABLE 20 LBS. + AH **CONTACT DEALER FOR PRICING**

**★ MEETS ASTM F2949-12 STANDARD TO BE COMPLIANT ★
WITH 2015 NCAA & NFHS RULES!**

F **PV Extenders**
Fits our #1188 and #1189 standards, respectively, as well as similar models and styles. Allows the standards to extend down to 5'6".

NEW! **1188EXT** **\$157.00/pr**
ALUMINUM * Cantabrian International 3' PV Extender
UPS SHIPPABLE 3 LBS./PR.
1189EXT **\$170.00/pr**
STEEL * Collegiate 3' PV Extender
UPS SHIPPABLE 10 LBS./PR.

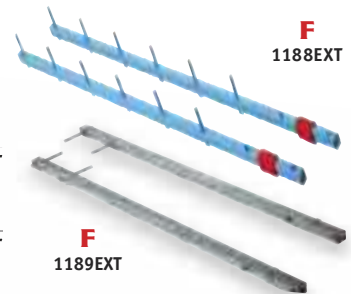

G PV Standard Extender
Solid construction, bolts into bottom of arm. Allows standard to extend down to 5 feet.

1272 **\$127.00/pr**
UPS SHIPPABLE 7 LBS./PR.
FOR 1190 / 1195



H Pole Vault & High Jump Laser Measuring Staff
Measures with the touch of a button. 60" laser measuring staff makes it easy to read. The staff is extremely quick and accurate. Measures from 5 feet on up.

1562 **\$400.00**
UPS SHIPPABLE 10 LBS. + AH

I **Aluminum Vault Box (Box only).**
Made of 1/8" 11-gauge aluminum construction. Conforms to NCAA and National HS federation recommendations.

Offers a 105° tilt on front.

1286 **\$415.00**

J **Aluminum Vault Box Lid (Lid Only.)**

1287 **\$165.00**

UPS SHIPPABLE 21 LBS.

UPS SHIPPABLE 14 LBS. + AH

K
1290 **Steel Vault Box (Box only).**
Heavy 12-gauge powder coated steel construction conforms to NCAA and National HS Federation recommendations.

1290 **\$240.00**
UPS SHIPPABLE 41 LBS.

L
1293 **Steel Vault Box Lid (Lid only).**
Also fits Blazer's #1280 Fiberglass Vault Box.

OFFERS A 105° TILT ON FRONT!

1293 **\$165.00**
UPS SHIPPABLE 30 LBS. + AH

M **Stainless Steel Vault Box (Box only).**
14-gauge stainless steel construction. Has the same features as the #1286 aluminum vault box.

1296 **\$550.00**
UPS SHIPPABLE 31 LBS.

N **Stainless Steel Vault Box Lid (Lid only).**

1297 **\$266.00**
UPS SHIPPABLE 23 LBS. + AH

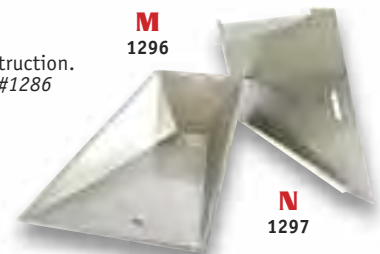

Please contact your dealer for your final price.

POLE VAULT PITS ★ COVERS **BLAZER**

★ ALL BLAZER PITS HAVE A ★ 10-YEAR WARRANTY ★



All Blazer Pits comply with the National High School Federation Rules and Regulations!

TRACK & FIELD

Q Double-Front Pole Vault Pits

Top pad & weather cover included!

Save time and wear and tear on pit! No need to flip front ends due to wind. Available on #8215 and #8205 pit models. Same specifications as the #8205 and #8215 PV Pits. Meets all high school and college specifications. **Olympic & Standard Base Pads are sold separately.** (See #8230 & #8231 on pg-8).

8205DF FREIGHT ONLY CONTACT DEALER FOR PRICING
OVERALL SIZE: 20'W x 33'L x 32"H

8215DF FREIGHT ONLY CONTACT DEALER FOR PRICING
OVERALL SIZE: 21'6"W x 33'L x 32"H

* PLEASE NOTE COLOR CHOICE BEHIND STOCK # WHEN ORDERING.
SEE LIST BELOW FOR AVAILABLE COLORS.



Q
8205DF
8215DF

P Pole Vault Pit

Top pad & weather cover included!

Meets all high school and college specifications. UV resistant 18-oz. coated vinyl. Three layers of lattice construction prime polyurethane foam filling. Mesh is 1300 denier fabric. Webbing used for snaps and D-rings is 1" nylon webbing with 6000 lb. breaking strength. Vinyl covered webbing for handles. All handles, snaps, buckles are re-enforced with vinyl backing and stitched multiple times for added strength, and are guaranteed for the life of the pit. • 3-base units • 2-front units • 2-front unit extenders. **Olympic & Standard Base Pads are sold separately.** (See #8230 & #8231 on pg-8).

8215 FREIGHT ONLY CONTACT DEALER FOR PRICING
OVERALL SIZE: 21'6"W x 23'6"L x 32"H

* PLEASE NOTE COLOR CHOICE BEHIND STOCK # WHEN ORDERING.
SEE LIST BELOW FOR AVAILABLE COLORS.

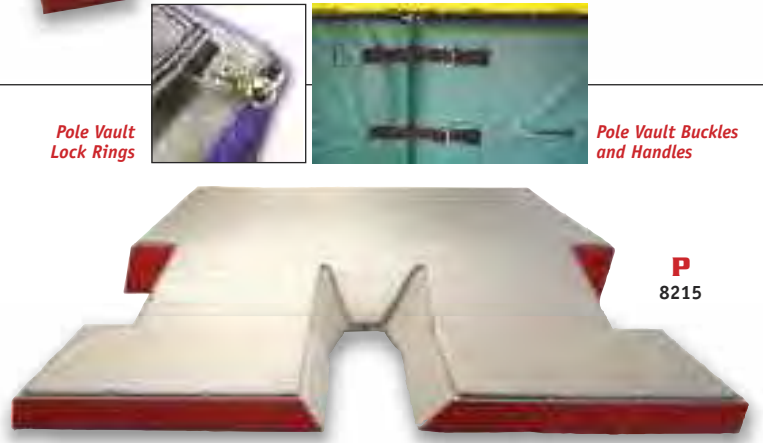

Pole Vault Lock Rings



Pole Vault Buckles and Handles

P
8215

Q Pole Vault Pit

Top pad & weather cover included!

Meets all high school and college specifications. Same specs as the #8215. • 3-base units • 2-front units • 2-front unit extenders. **Olympic & Standard Base Pads are sold separately.** (See #8230 & #8231 on pg-8). #8231 is pictured.

8205 FREIGHT ONLY CONTACT DEALER FOR PRICING
OVERALL SIZE: 20'W x 23'6"L x 32"H

* PLEASE NOTE COLOR CHOICE BEHIND STOCK # WHEN ORDERING.
SEE LIST BELOW FOR AVAILABLE COLORS.

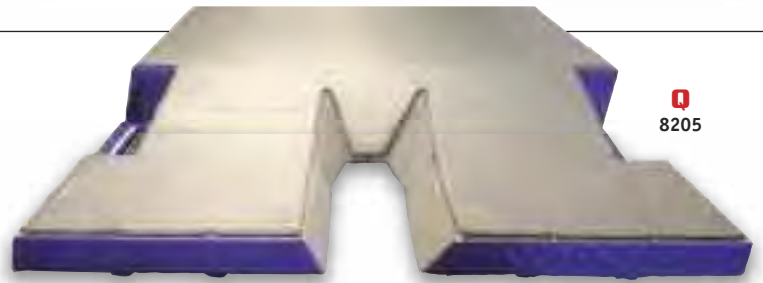

Q
8205

R Pole Vault Pit

Top pad and weather cover included!

Meets all high school specifications. Same specs as the #8215. • 3-base units • 2-front units. **Standard Base Pads are sold separately.** (See #8231 on pg-8).

8200 FREIGHT ONLY CONTACT DEALER FOR PRICING
OVERALL SIZE: 20'W x 20'6"L x 28"H

* PLEASE NOTE COLOR CHOICE BEHIND STOCK # WHEN ORDERING.
SEE LIST BELOW FOR AVAILABLE COLORS.



R
8200

NOT PICTURED Pole Vault Pit

Top pad & weather cover included!

Meets all high school specifications. Same specs as the #8215. • 3-base units • 2-front units • 2-front unit extenders. **Standard Base Pads are sold separately.** (See #8231 on pg-8).

8210 FREIGHT ONLY CONTACT DEALER FOR PRICING
OVERALL SIZE: 21'6"W x 23'6"L x 28"H

* PLEASE NOTE COLOR CHOICE BEHIND STOCK # WHEN ORDERING.
SEE LIST BELOW FOR AVAILABLE COLORS.

NOT PICTURED Pole Vault Pit Weather Covers

Weather covers are included with the purchase of a pit.

18-oz. coated vinyl – high UV resistance weather covers. Extends the life of your pit. Snaps to the bottom of the pit. Welded seams, and waterproof except for seams. **Available in Colors: Red, Lt. Gold, Orange, Royal, Navy, Forest, Maroon, Purple, Gray & Black.**

CALL FOR PRICING ON ★ CUSTOM ★ WEATHER COVERS!

- 8200WC** for #8200 PV Pit UPS SHIP 80 LBS. **8210WC** for #8210 PV Pit UPS SHIP 85 LBS.
- 8205WC** for #8205 PV Pit UPS SHIP 85 LBS. **8215WC** for #8215 PV Pit UPS SHIP 90 LBS.
- 8205DFWC** for #8205 Double-Front PV Pit UPS SHIP 108 LBS.
- 8215DFWC** for #8215 Double-Front PV Pit UPS SHIP 113 LBS.

CONTACT DEALER FOR PRICING

* PLEASE NOTE COLOR CHOICE BEHIND STOCK # WHEN ORDERING.
SEE LIST BELOW FOR AVAILABLE COLORS.

PIT COLORS	BASE					TOP		
	Red	Lt. Gold	Orange	Royal	Navy	Red	Royal	Forest
Forest	Maroon	Purple	Gray	Black	Gray	Black		

* PLEASE NOTE COLOR CHOICE BEHIND STOCK # WHEN ORDERING.



A
1212



A Steel Roll Away High Jump Standard
Powder coated uprights. 16" base with wheels. For High School or College. Adjusts from 2' to 8' in 1/4" intervals. Metric scale in cm 62 to 244.

1212 \$425.00/pr
UPS SHIPPABLE 2-PKGS
1 @ 23 LBS., 1 @ 38 LBS.

B
1215

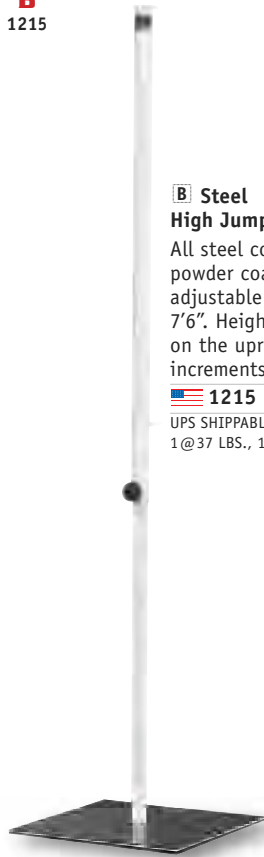

B Steel High Jump Standard
All steel construction, powder coated upright, adjustable from 12" to 7'6". Height is marked on the upright in 1/2" increments.

1215 \$212.00/pr
UPS SHIPPABLE 2-PKGS
1 @ 37 LBS., 1 @ 17 LBS.



C
1202



C Optional Wheel Kit for #1215
Included with both the #1209 and #1211 high jump standards.

1202 \$40.00/pr
UPS SHIPPABLE 5 LBS./PR.

D
1213



D Collegiate High Jump Standard
2-1/2" x 5.5" powder coated black finish with anodized aluminum uprights w/telescoping riser. Adjusts from 1-1/2' to 9'. Heights in English & metric. Steel rollaway base with adjustable leveling screws. NCAA and IAAF certified.

1213 \$810.00/pr
UPS SHIPPABLE 2-PKGS
1 @ 64 LBS., 1 @ 43 LBS. + AH

Adjustment Knob



E
1209



E ELITE Aluminum High Jump Standard with Aluminum Base

Adjusts from 2'3" to 8'6", that are marked in 1/2" increments, for all levels of competition. Heights are marked in English & also metric. Aluminum, 16" square, low profile base provides uniform stability. Powder coated upright. Attached wheels for easy portability. 3" wide lower standard upright.

1209 \$623.00/pr
UPS SHIPPABLE 2-PKGS 1 @ 27 LBS. + AH, 1 @ 16 LBS.

F
1211



F DELUXE Aluminum High Jump Standard with Steel Base

Adjusts from 2'3" to 8'6", marked in 1/2" increments, for all levels of competition. Heights are marked in English and metric. Steel, 16" square, low profile base provides uniform stability. upright. Attached wheels for easy portability. 3" wide lower standard upright.

1211 \$584.00/pr
UPS SHIPPABLE 2-PKGS
1 @ 27 LBS. + AH, 1 @ 39 LBS.

Please contact your dealer for your final price.

HIGH JUMP PITS ★ COVERS **BLAZER**



TRACK & FIELD

★ ALL BLAZER PITS HAVE A ★ 10-YEAR WARRANTY ★

Check out the **HIGH JUMP PACKAGE DEALS** on the next page!

G High Jump Pit

Top pad & weather cover included!

Made with UV resistant 18-oz. coated vinyl. Three layers of prime polyurethane foam filling. Mesh is 1300 denier fabric. Webbing used for snaps and d-rings are 1" nylon webbing with 6000 lb. breaking strength. Vinyl covered webbing for handles. All handles, snaps, buckles are re-enforced with vinyl backing and are guaranteed for the life of the pit. All stress areas, snaps, and D-rings are re-enforced and stitched multiple times for added strength. Meets all college and high school federation standards.

8110 FREIGHT ONLY **CONTACT DEALER FOR PRICING**

3-Base Units: 6'w x 10'L x 26"H
 Top Foam Pad: 18'w x 10'L x 2"H
OVERALL SIZE: 18'w x 10'L x 28"H with safety cutout for standards.

* PLEASE NOTE COLOR CHOICE BEHIND STOCK # WHEN ORDERING.
 SEE LIST BELOW FOR AVAILABLE COLORS.



G
8110

H High Jump Pit

Top pad & weather cover included!

The same features as the #8110.
 Meets all college and high school federation standards.

8105 FREIGHT ONLY **CONTACT DEALER FOR PRICING**

3-Base Units: 5'6"w x 10'L x 24"H
 Top Foam Pad: 16'6"w x 10'L x 2"H
OVERALL SIZE: 16'6"w x 10'L x 26"H with safety cutout for standards.

* PLEASE NOTE COLOR CHOICE BEHIND STOCK # WHEN ORDERING.
 SEE LIST BELOW FOR AVAILABLE COLORS.



H
8105

Pole Vault Lock Rings



Pole Vault Buckles and Handles



I High Jump Pit

Top pad & weather cover included!

The same features as the #8110.
 Meets all college and high school federation standards.

8100 FREIGHT ONLY **CONTACT DEALER FOR PRICING**

3-Base Units: 5'6"w x 8'L x 24"H
 Top Foam Pad: 16'6"w x 8'L x 2"H
OVERALL SIZE: 16'6"w x 8'L x 26"H

* PLEASE NOTE COLOR CHOICE BEHIND STOCK # WHEN ORDERING.
 SEE LIST BELOW FOR AVAILABLE COLORS.



I
8100

J ELEMENTARY ★ High Jump Pit

Weather cover included!

1-piece unit with no top pad. Recommended for elementary use only.

1251 200 LBS. FREIGHT ONLY **CONTACT DEALER FOR PRICING**

OVERALL SIZE: 12'w x 6'L x 24"H

* PLEASE NOTE COLOR CHOICE BEHIND STOCK # WHEN ORDERING.
 SEE LIST BELOW FOR AVAILABLE COLORS.



J
1251

CALL FOR PRICING ON ★ CUSTOM ★ WEATHER COVERS!



High Jump Pit Weather Covers

Weather covers are included with the purchase of a pit. 18-oz. coated vinyl – high UV resistance weather covers with the purchase of a pit. Extends the life of your pit. Snaps to the bottom of the pit. Welded seams, and waterproof except for seams. **Available in Colors:** Red, Lt. Gold, Orange, Royal, Navy, Forest, Maroon, Purple, Gray & Black.

- 8100WC for #8100 Pit** UPS SHIPPABLE 30 LBS.
 - 8105WC for #8105 Pit** UPS SHIPPABLE 35 LBS.
 - 8110WC for #8110 Pit** UPS SHIPPABLE 35 LBS.
 - 1251WC for #1251 Pit** UPS SHIPPABLE 30 LBS.
- CONTACT DEALER FOR PRICING**

* PLEASE NOTE COLOR CHOICE BEHIND STOCK # WHEN ORDERING. SEE LIST BELOW FOR AVAILABLE COLORS.

PIT COLORS	BASE					TOP				
	Red	Lt. Gold	Orange	Royal	Navy	Red	Royal	Forest	Gray	Black
	Forest	Maroon	Purple	Gray	Black					

* PLEASE NOTE COLOR CHOICE BEHIND STOCK # WHEN ORDERING.

★ ATTENTION! ★ TO ENSURE EXPANSION OF PITS OPEN IMMEDIATELY UPON RECEIPT!

★ ALL BLAZER PITS HAVE A ★ 10-YEAR WARRANTY ★



A
8110CP
8105CP

B
8100CP



C
82151CP



D
8205CP

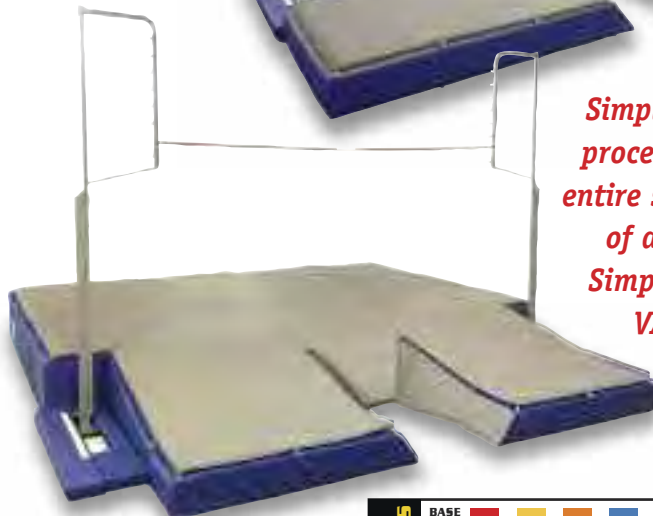

E
8200CP

YOUR BEST VALUE!

*Simplify the ordering process, improve your entire system and most of all **SAVE MONEY!** Simply by ordering a **VALUE PACKAGE!***

PIT COLORS	BASE					TOP		

* PLEASE NOTE COLOR CHOICE BEHIND STOCK # WHEN ORDERING.

★ HIGH JUMP ★

HJ Value Package #1

- A 8110CP HIGH JUMP Includes:**
 8110 High Jump Pit (18' x 10' x 28")
 8110WC Weather Cover
 1209 (pictured) Elite High Jump Standards (1-pair)
 1511 Deluxe Fiberglass Crossbar (1)

CONTACT DEALER FOR PRICING

HJ Value Package #2

- A 8105CP HIGH JUMP Includes:**
 8105 High Jump Pit (16'6" x 10' x 26")
 8105WC Weather Cover
 1211 Deluxe High Jump Standards (1-pair)
 1501 Practice Crossbar (1)

CONTACT DEALER FOR PRICING

HJ Value Package #3

- B 8100CP HIGH JUMP Includes:**
 8100 High Jump Pit (16'6" x 8' x 26")
 8100WC Weather Cover
 1211 Deluxe High Jump Standards (1-pair)
 1511 Deluxe Fiberglass Crossbar (1)

CONTACT DEALER FOR PRICING

HJ Value Package #4

- 1251CP HIGH JUMP Includes:**
 1251 Elementary Pit (12' x 6' x 24")
 1251WC Weather Cover
 1215 Steel High Jump Standards (1-pair)
 1501 Practice Crossbar (1)

CONTACT DEALER FOR PRICING

★ POLE VAULT ★

PV Value Package #1

- 82150CP POLE VAULT Includes:**
 8215 PV Pit (21'6" x 23'6" x 32")
 8215WC Weather Cover
 8230 Olympic Base Pads (1-pair)
 1190 Alum. PV Standards w/Alum Adj Base (1-pair)
 1512 Deluxe Fiberglass Crossbar (1)

CONTACT DEALER FOR PRICING

PV Value Package #2

- C 82151CP POLE VAULT Includes:**
 8215 PV Pit (21'6" x 23'6" x 32")
 8215WC Weather Cover
 8231 Standard Base Pads (1-pair)
 1195 Alum. PV Standards w/Steel Adj Base (1-pair)
 1512 Deluxe Fiberglass Crossbar (1)

CONTACT DEALER FOR PRICING

PV Value Package #3

- D 8205CP POLE VAULT Includes:**
 8205 PV Pit (20' x 23'6" x 32")
 8205WC Weather Cover
 8231 Standard Base Pads (1-pair)
 1190 Alum. PV Standards w/Adj Base (1-pair)
 1512 Deluxe Fiberglass Crossbar (1)

CONTACT DEALER FOR PRICING

PV Value Package #4

- E 8200CP POLE VAULT Includes:**
 8200 PV Pit (20' x 20'6" x 28")
 8200WC Weather Cover
 8231 Standard Base Pads (1-pair)
 1195 Alum. PV Standards w/Steel Base (1-pair)
 1502 Practice Crossbar (1)

CONTACT DEALER FOR PRICING



F
2712, 2714

FRONT AXLE HAS FULL 180° TURNING RADIUS!

F Super Carts, Aluminum Floor - Aluminum Frame
Same features as the wood floor-steel frame pit/hurdle carts. Constructed of tread-plate, rust free aluminum surface and frame. 1000 lb. capacity.

2712	4' x 8' 178 LBS. 2-BOXES - FREIGHT ONLY	\$1,557.00
2714	5' x 10' 234 LBS. 2-BOXES - FREIGHT ONLY	\$2,149.00



G
2711, 2713

FRONT AXLE HAS FULL 180° TURNING RADIUS!

G Super Carts, Wood Floor-Steel Frame
Transports all pits, hurdles, standards & MORE! Industrial-grade front axle swivel provides ease in steering. Heavy-duty plywood load surface, recessed in steel frame for protection. 16" fully pneumatic tires for easy pulling on most surfaces. Can be pulled behind a small tractor. 1000 lb. capacity.

2711	4' x 8' 211 LBS. 2-BOXES - FREIGHT ONLY	\$1,199.00
2713	5' x 10' 283 LBS. 2-BOXES - FREIGHT ONLY	\$1,546.00



H
2700

H Transport Cart
4' x 8', 17" off the ground. Easily moves up to 40-hurdles, pits, or other heavy equipment. (4) 10" pneumatic wheels, (2) that swivel, (2) that are fixed, provide easy pulling in grass or hard surfaces. Red painted steel construction throughout with a wooden deck. Extends life to pits by reducing wear that occurs while dragging them. 1000 lb. capacity.

2700	\$740.00
-------------	-----------------

233 LBS. 2-BOXES - FREIGHT ONLY

I Steel Equipment Wagon
Heavy-gauge, steel-mesh bed with fold-down sides. Bolts are welded to the bed for quick assembly. Towable. Pneumatic 13" Wheels. Capacity 6.0 cubic feet. Weight limit 1000 lbs.

1125	\$220.00
-------------	-----------------

UPS SHIPPABLE 78 LBS + AH



J High Jump and Pole Vault Pit Platforms
Constructed of non-corrosive aluminum.

8000PP Pit Platforms	FREIGHT ONLY	\$16.80/per square foot
-----------------------------	--------------	--------------------------------



K Pit Covers
Made of 10-oz. vinyl coated polyester mesh. Attached, unfilled weight pouches included.

1604	UPS SHIPPABLE	\$3.00/pr sq ft
-------------	---------------	------------------------

L Replacement Sandbag
For pit covers #1604. Velcro® closure. Sandbag arrives unfilled. 7" x 14".

1311	\$25.00/pr
-------------	-------------------

UPS SHIPPABLE 1 LB.

PIT COLORS

Red	Lt. Gold	Kelly	Navy	Gray	Black

* PLEASE NOTE COLOR CHOICE BEHIND STOCK # WHEN ORDERING.

M Weather Cover Insert
Extends life of pits. Helps to shed water off the weather cover.

1268	UPS SHIPPABLE 14 LBS	\$48.00
-------------	----------------------	----------------

N Practice Crossbars
OUR BEST CROSSBAR VALUE!
Meets NFHS specs.

1501	High Jump-13' 1-1/2" 6 LBS. FREIGHT ONLY	\$76.00
15013	HJ Set of 3 18 LBS. FREIGHT ONLY	\$206.00
1502	Pole Vault-14' 10" 7 LBS. FREIGHT ONLY	\$79.00
15023	PV Set of 3 21 LBS. FREIGHT ONLY	\$210.00

BEST BUY!

O Deluxe Crossbars
With double matte pultruded construction enables this crossbar to meet the Collegiate, International and High School Federation specs.
OUR FINEST CROSSBAR!

1511	High Jump-13' 1-1/2" 7 LBS. FREIGHT ONLY	\$89.00
15113	HJ Set of 3 21 LBS. FREIGHT ONLY	\$245.00
1512	Pole Vault-14' 10" 8 LBS. FREIGHT ONLY	\$96.00
15123	PV Set of 3 24 LBS. FREIGHT ONLY	\$250.00

P Crossbar Ends
Soft plastic ends that meet NFHS rule 2-6-4 which states that ends of crossbars may not be covered with rubber.

1530	for #1501, #1502 Crossbars	\$12.00/ea
1531	for #1511, #1512 Crossbars	\$12.00/ea

Crossbars are not guaranteed against breakage. Please inspect for visible and concealed damage before accepting delivery.

Q Elastic Foam Crossbar
Bright fluorescent orange color cord for easy visibility with black foam sections.

1503	UPS SHIPPABLE 1 LB.	\$23.00
-------------	---------------------	----------------

★ **EVENT TIMERS** ★

<p>A Oslo® 427 All-Purpose Stopwatch A 4940</p>  <ul style="list-style-type: none"> • TIMES SINGLE EVENTS • UNLIMITED SPLIT TIMES <p>Times up to 24-hours. Displays the time, calendar and alarm. Shows first and second place finish times. Has time-out (with pause) timing and 1/100 sec. resolution to 30-minutes.</p> <table border="1"> <tr> <td>4940 SILVER OXIDE 392 BATTERY</td> <td>\$10.50</td> </tr> <tr> <td>49406 OSLO® 427 6-COLOR PREPACK:</td> <td>\$63.00</td> </tr> <tr> <td colspan="2">● Orange ● Yellow ● Green ● Red ● Blue ● Purple</td> </tr> <tr> <td colspan="2">or specify individual colors as needed.</td> </tr> </table> <p>1-YEAR FACTORY WARRANTY ON WATCH</p>	4940 SILVER OXIDE 392 BATTERY	\$10.50	49406 OSLO® 427 6-COLOR PREPACK:	\$63.00	● Orange ● Yellow ● Green ● Red ● Blue ● Purple		or specify individual colors as needed.		<p>B Oslo Silver 2.0 B 4941</p>  <ul style="list-style-type: none"> • TWIN CHRONOGRAPH AND COUNTDOWN TIMER • EVENT, LAP OR SPLIT TIMING <p>Combines a multi-mode stopwatch with an easy-to-use countdown timer. 1/100 second precision to 10-hours. Two finish time memory recall. An unlimited number of time readings can be taken. Countdown timer shows time remaining; Counts up at completion. With audible alarm at completion of countdown. Countdown timer range is from 1-second to 10-hours. With an extra large display. Break-Away safety lanyard included.</p> <table border="1"> <tr> <td>4941 LR44 BATTERY</td> <td>\$15.00</td> </tr> </table> <p>1-YEAR FACTORY WARRANTY ON WATCH</p>	4941 LR44 BATTERY	\$15.00	<p>C SC-500E Single Event C 4946</p>  <ul style="list-style-type: none"> • START/STOP/RESET OPERATION • SILENT/AUDIBLE/WATER RESISTANT • ERROR FREE USE <p>One-step timing for all events. 1/100 second resolution to 10-hrs. Break-Away safety lanyard included.</p> <table border="1"> <tr> <td>4946 CR2032 BATTERY</td> <td>\$20.00</td> </tr> </table> <p>1-YEAR FACTORY WARRANTY ON WATCH</p>	4946 CR2032 BATTERY	\$20.00
4940 SILVER OXIDE 392 BATTERY	\$10.50													
49406 OSLO® 427 6-COLOR PREPACK:	\$63.00													
● Orange ● Yellow ● Green ● Red ● Blue ● Purple														
or specify individual colors as needed.														
4941 LR44 BATTERY	\$15.00													
4946 CR2032 BATTERY	\$20.00													

★ **COACHES STOPWATCHES & TIMERS** ★

<p>D Oslo Silver 60 D 4929</p>  <p>NEW!</p> <ul style="list-style-type: none"> • 60-DUAL SPLIT MEMORY RECALL FIRST 60-READINGS • LAP/SPLIT ON TOP ROW • UP/DOWN MEMORY RECALL • LAP COUNTER TO 199 READINGS <p>Countdown timer with 1/100 second resolution, presents time up to 10-hours for countdown. Temperature display in Fahrenheit and Celsius, time of day, alarm, and calendar. Water resistant up to 30-meters. 7-second amber backlight on demand. Break-Away safety lanyard included.</p> <table border="1"> <tr> <td>4929 LITHIUM CR2032 BATTERY</td> <td>\$30.00</td> </tr> </table> <p>1-YEAR FACTORY WARRANTY ON WATCH</p>	4929 LITHIUM CR2032 BATTERY	\$30.00	<p>E SC-505W 12-Memory Chrono E 4942</p>  <ul style="list-style-type: none"> • 12-MEMORY CHRONO • LAP/SPLIT OR EVENT TIMING <p>12-memory recall. Automatic lap counter to 199. 1/100 second precision to 24-hours. With auto lap/split release. 1st-12th place finish times. Water resistant to 30-meters. Break-Away safety lanyard included.</p> <table border="1"> <tr> <td>4942 LITHIUM CR2032 BATTERY</td> <td>\$25.50</td> </tr> <tr> <td>49426 SC-505W 6-COLOR PREPACK:</td> <td>\$153.00</td> </tr> <tr> <td colspan="2">● Orange ● Yellow ● Green ● Red ● Blue ● Purple</td> </tr> <tr> <td colspan="2">or specify individual colors as needed.</td> </tr> </table> <p>1-YEAR FACTORY WARRANTY ON WATCH</p>	4942 LITHIUM CR2032 BATTERY	\$25.50	49426 SC-505W 6-COLOR PREPACK:	\$153.00	● Orange ● Yellow ● Green ● Red ● Blue ● Purple		or specify individual colors as needed.		<p>F Ultrak 830 F 4830</p>  <ul style="list-style-type: none"> • SOLAR INDEX • 30-DUAL SPLIT RECALLABLE MEMORY <p>Solar index stopwatch accurately calculates temperature, humidity, heat index and dew point. Presettable countdown timer with an auto repeat function. 2-row display features LED backlight. Water resistant.</p> <table border="1"> <tr> <td>4830 SOLAR POWERED</td> <td>\$40.00</td> </tr> </table> <p>3-YEAR FACTORY WARRANTY ON WATCH</p>	4830 SOLAR POWERED	\$40.00													
4929 LITHIUM CR2032 BATTERY	\$30.00																										
4942 LITHIUM CR2032 BATTERY	\$25.50																										
49426 SC-505W 6-COLOR PREPACK:	\$153.00																										
● Orange ● Yellow ● Green ● Red ● Blue ● Purple																											
or specify individual colors as needed.																											
4830 SOLAR POWERED	\$40.00																										
<p>G Ultrak 495 Stopwatch G 4993</p>  <ul style="list-style-type: none"> • 100-DUAL SPLIT RECALLABLE MEMORY • MEMORY RECALL DURING OPERATION <p>100-memory with 3-row display. Take splits during recall mode. Bottom row displays running event time or running lap time. Measures to up to ten hours. Stroke frequency. Features time, calendar and alarm. Water-resistant.</p> <table border="1"> <tr> <td>4993 LITHIUM CR2032 BATTERY</td> <td>\$43.00</td> </tr> </table> <p>5-YEAR FACTORY WARRANTY ON WATCH</p>	4993 LITHIUM CR2032 BATTERY	\$43.00	<p>H Robic SC-877 Complete Training Stopwatch H 4951</p>  <ul style="list-style-type: none"> • 180-DUAL MEMORY RECALL • MEMORY RECALL DURING OPERATION <p>Total reading capacity of a 1000 times of previous Lap and Split cum, even while the stopwatch is running. There's no need to change modes when using recall. •Fast, •Slow, •Average lap time display recall on demand. Ascending or descending memory recall. Single, dual, or triple countdown timer. Program 3-countdown timers to run independent or simultaneously. With LED backlight. Water resistant and many more functions.</p> <table border="1"> <tr> <td>4951 LITHIUM CR2032 BATTERY</td> <td>\$50.00</td> </tr> </table> <p>1-YEAR FACTORY WARRANTY ON WATCH & BATTERY</p>	4951 LITHIUM CR2032 BATTERY	\$50.00	<p>I Robic SC-899 Triple Stopwatch I 4952</p>  <ul style="list-style-type: none"> • UP TO 540 MEMORY • MEMORY RECALL DURING OPERATION <p>Time 3-competitors at once. Customize your set up with 3-fully loaded time keeping modes: •1/Chronograph •2/Speed timer •3/Countdown timer. Can run simultaneously or separately. Select lap or cum split running times. Review each w/o leaving the stopwatch. Recall while timer is running, can immediately take another reading without changing modes. With LED backlight. Water resistant and more!</p> <table border="1"> <tr> <td>4952 LITHIUM CR2032 BATTERY</td> <td>\$60.00</td> </tr> </table> <p>1-YR FACTORY WARRANTY ON WATCH & BATTERY</p>	4952 LITHIUM CR2032 BATTERY	\$60.00																			
4993 LITHIUM CR2032 BATTERY	\$43.00																										
4951 LITHIUM CR2032 BATTERY	\$50.00																										
4952 LITHIUM CR2032 BATTERY	\$60.00																										
<p>J Ultrak 496 J 4960</p>  <ul style="list-style-type: none"> • 500-DUAL SPLIT RECALLABLE MEMORY • CHOOSE RUNNING EVENT TIME OR RUNNING LAP TIME <p>3-line display in a classic case design. Measures up to 10-hours with 1/100 second resolution. Stroke frequency along with time & calendar.</p> <table border="1"> <tr> <td>4960 LITHIUM CR2032 BATTERY</td> <td>\$50.00</td> </tr> </table> <p>5-YEAR FACTORY WARRANTY ON WATCH</p>	4960 LITHIUM CR2032 BATTERY	\$50.00	<p>K Ultrak-L10 Lane Timer K 4932</p>  <p>Comes with a computer interface, can time track races with up to 10-lanes as well as road races (cross country, 10K's, marathons, etc.) with up to 8,000 participants. Linkgate connects the 10-lane buttons to a separate unit, eliminating tangled wires. Bib numbers can be preassigned to lanes in the track mode and at the finish for road races. Data can be uploaded to a PC or printed out during or after events for later review. Includes 2-rolls of thermal paper.</p> <table border="1"> <tr> <td>4932 1-Button Set UPS SHIP 4 LBS.</td> <td>\$575.00</td> <td>4934 8-Button Set UPS SHIP 4 LBS.</td> <td>\$660.00</td> </tr> <tr> <td>4933 6-Button Set UPS SHIP 4 LBS.</td> <td>\$635.00</td> <td>4935 10-Button Set UPS SHIP 4 LBS.</td> <td>\$675.00</td> </tr> <tr> <td>49310WBR 10 Wireless Buttons with Receiver (L10 not included)</td> <td>\$425.00</td> <td></td> <td></td> </tr> <tr> <td>4931 Additional Button</td> <td>\$20.00</td> <td></td> <td></td> </tr> <tr> <td>4931CASE Carrying Case for Ultrak L10</td> <td>\$39.00</td> <td></td> <td></td> </tr> <tr> <td>4930 Thermal Paper 3-Rolls per box - Each roll 370" long</td> <td>\$23.00</td> <td></td> <td></td> </tr> </table> <p>1-YEAR FACTORY WARRANTY ON WATCH & BATTERY</p>	4932 1-Button Set UPS SHIP 4 LBS.	\$575.00	4934 8-Button Set UPS SHIP 4 LBS.	\$660.00	4933 6-Button Set UPS SHIP 4 LBS.	\$635.00	4935 10-Button Set UPS SHIP 4 LBS.	\$675.00	49310WBR 10 Wireless Buttons with Receiver (L10 not included)	\$425.00			4931 Additional Button	\$20.00			4931CASE Carrying Case for Ultrak L10	\$39.00			4930 Thermal Paper 3-Rolls per box - Each roll 370" long	\$23.00		
4960 LITHIUM CR2032 BATTERY	\$50.00																										
4932 1-Button Set UPS SHIP 4 LBS.	\$575.00	4934 8-Button Set UPS SHIP 4 LBS.	\$660.00																								
4933 6-Button Set UPS SHIP 4 LBS.	\$635.00	4935 10-Button Set UPS SHIP 4 LBS.	\$675.00																								
49310WBR 10 Wireless Buttons with Receiver (L10 not included)	\$425.00																										
4931 Additional Button	\$20.00																										
4931CASE Carrying Case for Ultrak L10	\$39.00																										
4930 Thermal Paper 3-Rolls per box - Each roll 370" long	\$23.00																										

Please contact your dealer for your final price.

MULTI-LANE TIMERS ★ DISCUS CAGES **BLAZER**

TRACK & FIELD

★ **MULTI-LANE TIMERS** ★

L Ultrak 499

2000 dual split recallable memory. Multiple event memory and memory review during operation. Automatic split release, continuous display of event time. Time, calendar and daily alarm. With dual countdown timer. The printer has an automatic printout of the year, month, date and time.



4995 \$310.00

Ultrak 499 Watch & Printer

4996 \$70.00

Ultrak 499 Stopwatch

4997 \$260.00

Ultrak 499 Printer

4998 Thermal Paper \$11.00

Ultrak 498 & 499 5-rolls per box.
Prints 1200 lines. Each roll 180" long

L
4995

M Ultrak 498 Stopwatch with Printer

2000 dual split, multiple event memory. With continuous display of event time. Automatic split release. Dual countdown timers. Also with time, calendar & alarm. Printout selection of lap and /or cum splits & speed. Automatic printout of year, month, date and time.



4994 \$360.00

Includes 2-Rolls of Paper

4998 Thermal Paper \$11.00

Ultrak 498 & 499 5-rolls per box - Each roll 180" long
Prints 1200 lines.

M
4994

★ **DISCUS CAGES** ★ **5-YEAR WARRANTY ON POLES!**



N
1427
STRAIGHT POSTS



N
1420, 1424
CANTILEVERED POSTS

**\$100
FREIGHT**

N Steel ★ Discus Cages

One-piece nylon top cabled net is raised using a "flagpole" design rope system. Quick detach net clips for fast and easy net removal to prevent theft. 12' or 14' tall net (with 3-warning signs) provides protection to spectators. Posts drop 9" into PVC pipe ground sleeves which are cemented in. Included weather treated net catches discus preventing ricochet effect. Meets all HS Federation rules. **5-year warranty on poles!**

1427 STRAIGHT Steel Posts with 12' NET \$1,470.00
2.375" O.D. 152 LBS./ PR. 7-BOXES - FREIGHT ONLY

1420 CANTILEVERED Steel Posts with 12' NET \$1,800.00
2.375" O.D. 152 LBS./ PR. 7-BOXES - FREIGHT ONLY

1424 CANTILEVERED Steel Posts with 14' NET \$2,300.00
2.375" O.D. 165 LBS./ PR. 7-BOXES - FREIGHT ONLY



O
1428

**\$100
FREIGHT**

**NEW
LOWER
\$**

O Elite Aluminum ★ Discus Cage NEW LOWER PRICING FOR 2018!

High quality aluminum poles with 34" rolled offset. Heavy duty solid core poly vinyl ground tubes are used that will not corrode but act as glides for the poles allowing them to slide in easily and resist dirt. The ground sleeve stop bolts and net anchor bolts are stainless steel to resist corrosion. The ground sleeves come with covers to keep the pole and anchor holes clean. Includes a weather treated 58' x 14' Net which attaches with cinch straps and spring clips for quick removal. Meets all HS federation rules. **5-year warranty on poles!**

1428 CURVED Aluminum Posts with 14' NET \$2,400.00
2.85" O.D. 275 LBS./ PR. 2-BUNDLES + 2-BOXES - FREIGHT ONLY

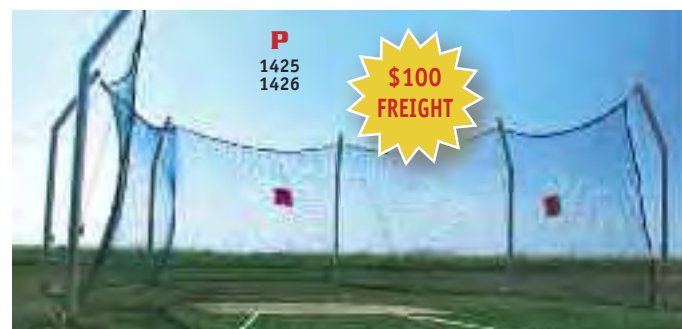

P
1425
1426

**\$100
FREIGHT**

P Aluminum ★ Discus Cages

One-piece nylon top cabled net is raised using a "flagpole" design rope system. Quick detach net clips for fast and easy net removal to prevent theft. 12' or 14' tall net (with 3-warning signs) provides protection to spectators. Posts drop into ground sleeves which are cemented in. Included weather treated net catches discus preventing ricochet effect. Meets all HS Federation rules. **5-year warranty on poles!**

1425 CANTILEVERED Aluminum Posts with 12' NET \$2,250.00
234 LBS./ PR. 8-BOXES - FREIGHT ONLY

1426 CANTILEVERED Aluminum Posts with 14' NET \$2,600.00
264 LBS./ PR. 8-BOXES - FREIGHT ONLY



Q Weather Treated Replacement Net

One-piece nylon top replacement net for discus cages #1427, #1420, #1424, #1425 and #1426.

1421 Replacement Net - 58' X 14'
UPS SHIPPABLE 27 LBS \$650.00

1422 Replacement Net - 58' X 12'
UPS SHIPPABLE 26 LBS \$600.00

**POSITIONABLE NETS ARE EASY TO RAISE & LOWER
★ FOR REMOVAL ON DISCUS CAGES! ★**

A ★ VERY HIGH SPIN ★ TOP THROWERS

88 TO 85% RIM WEIGHTS

		
<p>A GOLD 88% Brass Rim XPT Side Plate Technology</p>	<p>A CANTABRIAN GOLD HYPER-SPIN 85% Brass Rim World leader in Olympic Gold</p>	<p>A BLACK STEALTH 85% Stainless Steel Rim XTP Side Plate Technology</p>
<p>1321 1K Women's \$199.00 UPS SHIP 3 LBS.</p> <p>1322 1.6K Boys \$205.00 UPS SHIP 4 LBS.</p> <p>1323 2K College \$215.00 UPS SHIP 5 LBS.</p>	<p>1353 1K Women's \$299.00 UPS SHIP 3 LBS.</p> <p>1354 1.6K Boys \$310.00 UPS SHIP 4 LBS.</p> <p>1355 2K College \$320.00 UPS SHIP 5 LBS.</p>	<p>1324 1K Women's \$156.00 UPS SHIP 3 LBS.</p> <p>1325 1.6K Boys \$179.00 UPS SHIP 4 LBS.</p> <p>1326 2K College \$189.00 UPS SHIP 5 LBS.</p>

DISCUS SELECTION CHART		
RECOMMENDED RIM WEIGHT % TO THROWING DISTANCE		
DISCUS RIM WEIGHT	DISCUS THROWING DISTANCE	
	HIGH SCHOOL GIRLS	HIGH SCHOOL BOYS
70%-73%	100' * 125'	80' * 110'
73%-75%	120' * 150'	110' * 130'
75%-80%	140' * 160'	130' * 160'
78%-85%	150' * 165'	155' * 170'
85%-90%	160' or more	
85%-89%		165' * 180'
90% or more	175' * 200'	
88% or more		180' or more

ALL COMPETITION DISCUS MEET ★ NCAA & NFHS SPECIFICATION! ★

When you throw the high % rim weight, it also depends on how the discus is being thrown and how it leaves the hand (spin).

B ★ HIGH SPIN ★ ADVANCED THROWERS

85 TO 80% RIM WEIGHTS

			
<p>B GALAXY FLIGHT 85% Stainless Steel Rim High Impact ABS Side Plate</p>	<p>B BLAZE 83% Steel Rim High Impact ABS Side Plate</p>	<p>B CANTABRIAN BLACK OLYMPIA 82% Stainless Steel Rim High Impact ABS Side Plate</p>	<p>B LAZER 80% Steel Rim High Impact ABS Side Plate</p>
<p>1316 1K Women's \$98.00 UPS SHIP 3 LBS.</p> <p>1315 1.6K Boys \$123.00 UPS SHIP 4 LBS.</p> <p>1317 2K College <i>Color Purple</i> \$138.00 UPS SHIP 5 LBS.</p>	<p>1343 1K Women's \$110.00 UPS SHIP 3 LBS.</p> <p>1344 1.6K Boys \$115.00 UPS SHIP 4 LBS.</p> <p>1345 2K College \$125.00 UPS SHIP 5 LBS.</p>	<p>1356 1K Women's \$199.00 UPS SHIP 3 LBS.</p> <p>1357 1.6K Boys \$210.00 UPS SHIP 4 LBS.</p> <p>1358 2K College \$220.00 UPS SHIP 5 LBS.</p>	<p>1351 1K Women's \$76.00 UPS SHIP 3 LBS.</p> <p>1350 1.6K Boys \$84.00 UPS SHIP 4 LBS.</p> <p>1352 2K College \$105.00 UPS SHIP 5 LBS.</p>

C ★ MEDIUM SPIN ★ INTERMEDIATE THROWERS

80 TO 75% RIM WEIGHTS

		
<p>C PRESTIGE 80% Galvanized Steel Rim High Impact ABS Side Plate</p>	<p>C CANTABRIAN RED INTERNATIONAL 75% Galvanized Steel Rim High Impact ABS Side Plate</p>	<p>C TARGET 75% Galvanized Steel Rim High Impact ABS Side Plate</p>
<p>1365 1K Women's \$50.00 UPS SHIP 3 LBS.</p> <p>1366 1.6K Boys \$60.00 UPS SHIP 4 LBS.</p>	<p>1359 1K Women's \$85.00 UPS SHIP 3 LBS.</p> <p>1360 1.6K Boys \$95.00 UPS SHIP 4 LBS.</p> <p>1361 2K College \$105.00 UPS SHIP 5 LBS.</p>	<p>1332 1K Women's \$39.00 UPS SHIP 3 LBS.</p> <p>1331 1.6K Boys \$49.00 UPS SHIP 4 LBS.</p> <p>1333 2K College \$56.00 UPS SHIP 5 LBS.</p>

Please contact your dealer for your final price.



DISCUS ★ CARRIERS ★ RINGS **BLAZER**

TRACK & FIELD



D ★ LOW SPIN ★ BEGINNING THROWERS
70% & LOWER RIM WEIGHTS • CENTER WEIGHTED

 <p>D LAMINATE WOOD 70% Galvanized Steel Rim Waterproof Laminated Wood Plate</p> <p>1341 1K Women's \$28.00 UPS SHIP 3 LBS.</p> <p>1340 1.6K Boys \$35.00 UPS SHIP 4 LBS.</p> <p>1342 2K College \$38.00 UPS SHIP 5 LBS.</p>	 <p>D CANTABRIAN BLUE CHALLENGER 65 to 70% Steel Rim Heavy Duty ABS Side Plate</p> <p>1362 1K Women's \$65.00 UPS SHIP 3 LBS.</p> <p>1363 1.6K Boys \$76.00 UPS SHIP 4 LBS.</p> <p>1364 2K College \$92.00 UPS SHIP 5 LBS.</p>	 <p>D CORE DISCUS 65-70% Galvanized Steel Rim High Impact ABS Side Plate</p> <p>1376 1K Women's \$43.00 UPS SHIP 3 LBS.</p> <p>1377 1.6K Boys \$57.00 UPS SHIP 4 LBS.</p>	 <p>D RUBBER ONE PIECE CONSTRUCTION Official Size and Weight</p> <p>1338 1K Women's \$14.00 UPS SHIP 3 LBS.</p> <p>1337 1.6K Boys \$15.00 UPS SHIP 4 LBS.</p> <p>1339 2K College \$17.00 UPS SHIP 5 LBS.</p>
--	--	---	---

E ★ INDOOR ★ TRAINING DISCUS

 <p>E INDOOR RUBBER DISCUS Official Non-Marring</p> <p>1411 1K Women's \$20.00 UPS SHIP 3 LBS.</p> <p>1412 1.6K Boys \$24.00 UPS SHIP 4 LBS.</p> <p>1413 2K College \$26.00 UPS SHIP 5 LBS.</p>	 <p>E RUBBER DISCUS W/ADJUSTABLE STRAP Great for Practice Turns</p> <p>1307 1K Women's \$23.00 UPS SHIP 3 LBS.</p> <p>1308 1.6K Boys \$27.00 UPS SHIP 4 LBS.</p> <p>1309 2K College \$29.00 UPS SHIP 5 LBS.</p>	 <p>E PRACTICE RUBBER DISCUS One Piece Construction</p> <p>1306 1K Women's \$7.00 UPS SHIP 3 LBS.</p> <p>1305 1.6K Boys \$11.00 UPS SHIP 4 LBS.</p>
--	--	---

★ DISCUS & SHOT PUT ★ CARRIERS ★ DISCUS RING

<p>F 2150</p>  <p>F Discus/Shot Carrier Reinforced nylon bag with sturdy handle. Holds 2-shots or 2-discus.</p> <p>2150 UPS SHIPPABLE 1 LB. \$12.00</p>	<p>G 2155</p>  <p>G Discus/Shot Carrier with Shoulder Strap The 2150 carrier with strap for extra convenience.</p> <p>2155 UPS SHIPPABLE 1 LB. \$15.00</p>	<p>H 2156</p>  <p>H Two-Shot Bag Heavy vinyl bag holds 2-shots. Carrying handle plus removable shoulder strap. Snap closure plus side zipper.</p> <p>2156 \$20.00 UPS SHIPPABLE 2 LBS.</p>
<p>I 2157</p>  <p>I Multi Shot/Discus Carrier Constructed from heavy nylon netting. Holds multiple shot and discus.</p> <p>2157 \$12.00 UPS SHIPPABLE 1 LBS.</p>	<p>J 2120</p>  <p>J Mesh Shot Put Carrier Constructed from heavy, woven polyethylene rope.</p> <p>2120 \$7.50 UPS SHIPPABLE 1 LB.</p>	<p>K 1255</p>  <p>K Discus Ring Uses 1" x 3/4" x 1/4" aluminum angle. Holes are provided for anchoring. Meets IAAF, NCAA® and NFHS rules.</p> <p>1255 Discus Ring 8' x 2-1/2" D \$160.00 UPS SHIPPABLE 14 LBS. + AH, 4-SECTIONS</p>

★ SAVE MONEY WHEN YOU PURCHASE VALUE PACKAGES IN 1-EASY STEP! ★

A  **A Stainless Steel Shot**
Precision manufactured to the highest standards. Machine turned at a max. ovalization of 0.5 mm and weight tolerance of +25 grams. Unsurpassed quality. UPS shippable. IAAF certified.

2114	4K (95mm)	\$121.00
2112	12 lbs. (103mm)	\$135.00
2116	16 lbs. (110mm)	\$154.00

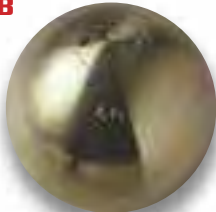

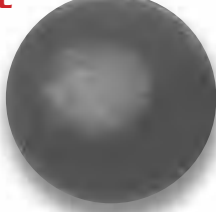

B  **B Brass Shot**
Blazer's Olympian brass shot is lathe turned to minimum diameter allowed in competition. Machine finish gives an excellent grip. Unsurpassed quality. UPS shippable.

2004	4K (95mm)	\$123.00
2012	12 lbs. (103mm)	\$133.00
2016	16 lbs. (110mm)	\$146.00

C  **C Iron Shot**
No indentations or abrasions, cast, not completely smooth. UPS shippable.

1932	2K	\$17.00
1940	Women's 4K (102mm)	\$20.00
1950	Elementary 6 lbs. (92mm)	\$16.00
1960	8 lbs. (98mm)	\$20.00
1970	10 lbs. (106mm)	\$25.00
1980	Boys 12 lbs. (114mm)	\$29.00
1990	College 16 lbs. (125mm)	\$35.00
1988	College 18 lbs. (132mm)	\$39.00
1989	College 20 lbs. (137mm)	\$44.00

D  **D Competition Turned Steel Shot**
High quality turned steel shot. Machine turned with maximum ovalization 0.5 mm and weight tolerance of +25 grams. Surface painted. UPS shippable.

NEW! 2215	Women's 4K (109mm)		\$92.00
2212	Boys 12 lbs. (114mm)		\$89.00
NEW! 2213	Boys 12 lbs. (117mm)		\$95.00
2216	College 16 lbs. (113mm)		\$100.00
NEW! 2217	College 16 lbs. (129mm)		\$115.00

YOUR BEST BUY!

E SHOT PUT F VALUE PACKAGES ★

E BOY'S INCLUDE:

1992 12 LB. Turned Iron Shot Put
1980 12 LB. Cast Iron Shot Put
1920 12 LB. Indoor Shot Put
2157 Multi-Shot/Discus Carrier

1372 **\$190.00**
UPS SHIPPABLE 36 LBS.

F WOMEN'S INCLUDE:

1991 4K Turned Iron Shot Put
1940 4K Cast Iron Shot Put
1910 4K Indoor Shot Put
2157 Multi-Shot/Discus Carrier

1373 **\$163.00**
UPS SHIPPABLE 24 LBS.



G IMPLEMENT H VALUE PACKAGES ★

G BOY'S INCLUDE:

1337 Boys Rubber Discus
1340 Boys Lamine Discus
1350 Boys Lazer Discus
1980 Boys Iron Shot
2212 Boys Turned Steel Shot
2155 Shot/Discus Bag w/Shoulder Strap (2)

1370 **\$299.00**
UPS SHIPPABLE 41 LBS.

H WOMEN'S INCLUDE:

1338 Women's Rubber Discus
1341 Women's Lamine Discus
1351 Women's Lazer Discus
1940 Women's Iron Shot
2215 Women's Turned Steel Shot
2155 Shot/Discus Bag w/Shoulder Strap (2)

1371 **\$277.00**
UPS SHIPPABLE 30 LBS.



I DISCUS J VALUE PACKAGES ★

I BOY'S INCLUDE:

1340 1.6K Laminated Wood Discus
1331 1.6K Target Discus
1412 1.6K Indoor Discus
2155 Shot/Discus Bag w/Shoulder Strap

1374 **\$130.00**
UPS SHIPPABLE 12 LBS.



J WOMEN'S INCLUDE:

1341 1K Laminated Wood Discus
1332 1K Target Discus
1411 1K Indoor Discus
2155 Shot/Discus Bag w/Shoulder Strap





1375 **\$109.00**
UPS SHIPPABLE 9 LBS.









K  **K Turned Iron Shot**
Precision machine turned. Turned Iron Shot is *perfectly balanced*. Weight plus .05 grams. UPS shippable.

1991	Women's 4K (109mm)		\$55.00
1992	Boys 12 lbs. (115mm)		\$59.00
1993	College 16 lbs. (128mm)		\$69.00

L  **L Indoor Shot**
Hard shell gives the feel of an outdoor shot, but soft enough to not mark or damage gym floors. Neon red/orange color gives high visibility in indoor environments. Calibrated to correct weight. **Guaranteed against breakage for one season.** UPS shippable.

 1890	Elementary 6 lbs. (101mm)	\$57.00
 1900	8 lbs. (114mm)	\$63.00
 1910	Women's 4K (114mm)	\$66.00
 1920	Boys 12 lbs. (127mm)	\$79.00
 1930	College 16 lbs. (139mm)	\$99.00

M  **M Soft Shell Indoor Shot**
Soft outer shell is ideal for indoor wood gym surfaces. Will not mark or damage gym surfaces. Calibrated to correct weight. **Guaranteed against breakage for one season.** UPS shippable.

 1885	Elementary 6 lbs. (101mm)	\$56.00
 1886	8 lbs. (114mm)	\$60.00
 1887	Women's 4K (114mm)	\$64.00
 1888	Boys 12 lbs. (127mm)	\$77.00
 1889	College 16 lbs. (139mm)	\$97.00









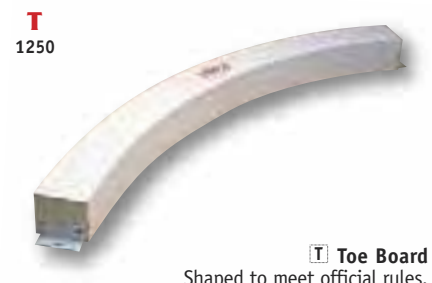

★ TAKE-OFF BOARDS ★

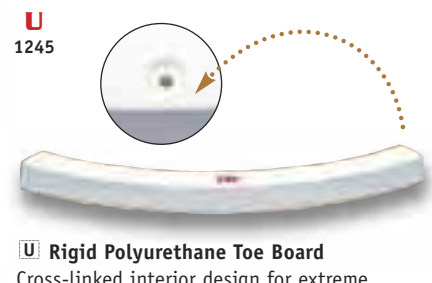
<p>N 1248</p>  <p>N Long Jump Take-Off Board 8" Wide Manufactured from laminated wood. Sealed, primed, and finished with a white enamel paint. For high school and collegiate use. Meets rule book specifications. 2-1/2" x 8" x 48".  1248 UPS SHIPPABLE 23 LBS. \$175.00</p>	<p>O 1242</p>  <p>O Long Jump Take-Off Board 20" wide Manufactured from marine grade plywood to meet high school rules. Sealed, primed, and finished with a white enamel paint. 2-3/4" x 20" x 48". 1242 \$172.00  UPS SHIPPABLE 31 LBS.</p>
--	---

★ LONG JUMP TRAYS ★

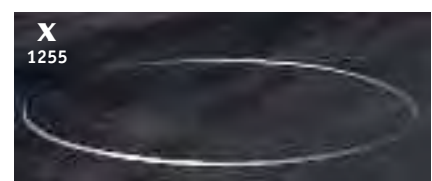
<p>P 1249</p>  <p>P Stainless Steel Long Jump Tray with 8" Board Designed to work with our #1248 board (included). 16-gauge stainless steel with 1" square-tubing frame. Boards must be removed when not in use. 6-leveling bolts provided to level board with runway. Drain holes for easy water drainage.  1249 UPS SHIPPABLE 53 LBS. \$415.00</p>	<p>Q 1243</p>  <p>Q Stainless Steel Long Jump Tray With 20" Board Consists of a 20" stainless steel tray with drain holes. Boards must be removed when not in use. Includes #1242 20" board.  1243 \$450.00 UPS SHIPPABLE 54 LBS.</p>	<p>R 1244 1247</p>  <p>R Stainless Steel Long Jump Tray with Lid and Indicator Board Model #1248 laminated wood board with 4" wide indicator board. 16-gauge stainless steel with 1" square-tubing frame. 6-leveling bolts provided to level board with runway. Indicator board is for plasticine application. Boards must be removed when not in use. Indicator board identifies faults. 12-gauge steel lid is provided to be placed in tray when boards are removed for storage.  1244 Without Lid UPS SHIPPABLE 57 LBS. \$550.00  1247 With Lid (Pictured) UPS SHIPPABLE 79 LBS. \$611.00</p>
--	--	---

★ TOE BOARDS & RINGS ★

<p>S 1253</p>  <p>S Metal Toe Board Will not warp, split, or deteriorate in weather. Radiating lines speed up accurate measurement. 1253 UPS SHIPPABLE 25 LBS. \$215.00</p>	<p>T 1250</p>  <p>T Toe Board Shaped to meet official rules. Weather-resistant and colorfast.  1250 Fiberglass UPS SHIPPABLE 10 LBS. \$237.00</p>	<p>U 1245</p>  <p>U Rigid Polyurethane Toe Board Cross-linked interior design for extreme strength. Waterproof and UV protected.  1245 UPS SHIPPABLE 13 LBS. \$260.00</p>
<p>V 1252</p>  <p>V Aluminum Toe Board Cast aluminum construction for long lasting durability. Recessed for ring. Meets all rule specifications. 1252 UPS SHIPPABLE 27 LBS. \$410.00</p>	<p>W 1265</p>  <p>W Shot Put Ring Uses 1" x 3/4" x 1/4" aluminum angle. Holes are provided for anchoring. Meets IAAF, NCAA® and NFHS rules.  1265 7' Diameter \$160.00 UPS SHIPPABLE 11 LBS. + AH, 3-SECTIONS (Toe board ordered separately).</p>	<p>X 1255</p>  <p>X Discus Ring Uses 1" x 3/4" x 1/4" aluminum angle. Holes are provided for anchoring. Meets IAAF, NCAA® and NFHS rules.  1255 8' x 2 1/2" Diameter \$160.00 UPS SHIPPABLE 14 LBS. + AH, 4-SECTIONS</p>
<p>  1266 Hammer Ring 7' Diameter \$160.00 UPS SHIPPABLE 13 LBS. + AH, 4-SECTIONS</p>		

A 1119 ★ USED BY THE UNIVERSITY OF NEBRASKA! ★

TOP OF THE LINE!

NEW!

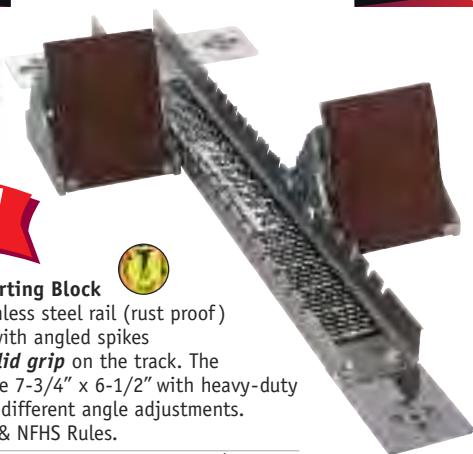

A University Starting Block
4" wide heavy stainless steel rail (rust proof) and spike plates, with angled spikes that provide a solid grip on the track. The aluminum shoes are 7-3/4" x 6-1/2" with heavy-duty rubber pads and 4-different angle adjustments. Meets IAAF, NCAA & NFHS Rules.

1119 UPS SHIPPABLE 32 LBS. **\$375.00**

B 1120



B Basic All-Surface Starting Block
All the features of the #1110 model except the pedal, which adjusts by tilting and sliding along the runner.

1120 UPS SHIPPABLE 12 LBS. **\$65.00**

C 1110

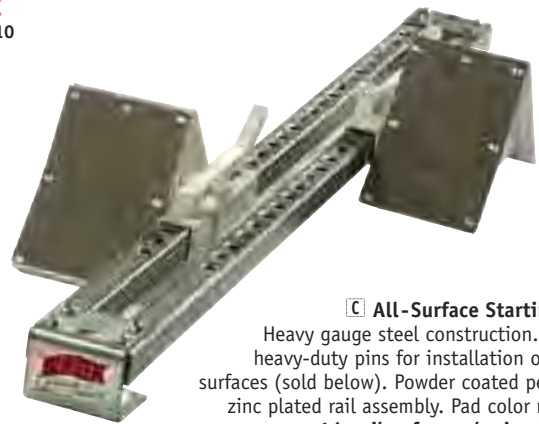

C All-Surface Starting Block
Heavy gauge steel construction. Optional heavy-duty pins for installation on dirt surfaces (sold below). Powder coated pedals and zinc plated rail assembly. Pad color may vary. **14-spikes for anchoring included.**

1110 UPS SHIPPABLE 13 LBS. **\$73.00**

D 1114

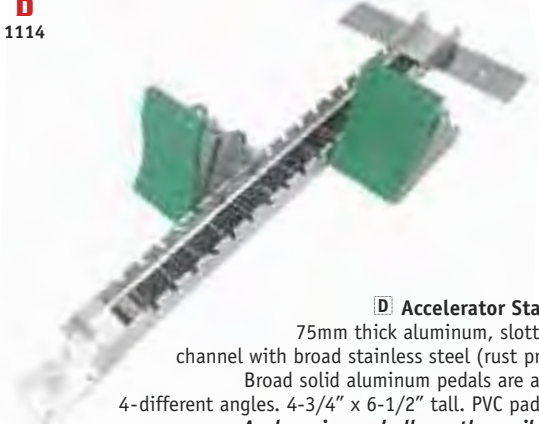

D Accelerator Starting Block
75mm thick aluminum, slotted anodized channel with broad stainless steel (rust proof) plates. Broad solid aluminum pedals are adjustable to 4-different angles. 4-3/4" x 6-1/2" tall. PVC pads on pedals. **Anchor pins and all-weather spikes included.**

1114 UPS SHIPPABLE 16 LBS. **\$111.00**

E 1117

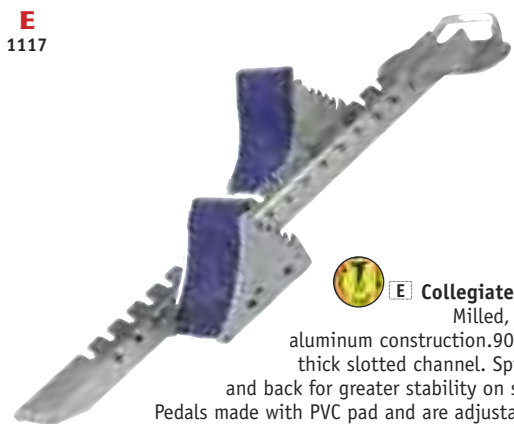

E Collegiate Starting Block
Milled, solid, anodized, aluminum construction. 90mm long x 7mm thick slotted channel. Spikes in the front and back for greater stability on synthetic tracks. Pedals made with PVC pad and are adjustable at 5-angles. 7-1/2" x 5" shoes. Pad color may vary. IAAF certified.

1117 UPS SHIPPABLE 1 @ 8 LBS. & 1 @ 4 LBS. **\$160.00**

F 1118

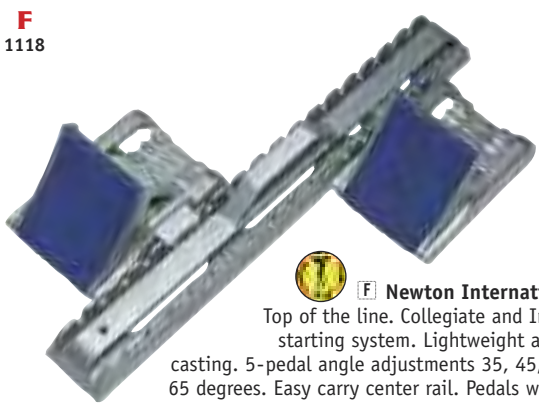

F Newton International Block
Top of the line. Collegiate and International starting system. Lightweight all aluminum casting. 5-pedal angle adjustments 35, 45, 55, 60 and 65 degrees. Easy carry center rail. Pedals will not come off rail during transport. Threaded spikes for synthetic surface. **Two 6" spikes for dirt are included.** IAAF certified.

1118 UPS SHIPPABLE 16 LBS. **\$308.00**

G 1122

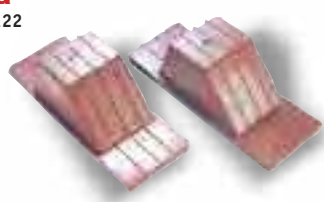

G Indoor Starting Blocks
Brown plastic blocks. Adheres to any clean floor without glue or pins. Easily removable. (Recommended 2nd person support blocks with feet from behind).

1122 **\$24.00**
UPS SHIPPABLE 7 LBS.

H 1121



H Starting Block Anchor Pins
For use with starting block #1120 and starting block #1110. (Not included with the purchase of the block itself).

1121 **\$3.75/ea**
UPS SHIPPABLE 1 LB.

Please contact your dealer for your final price.

CARTS ★ ROLL-OUT RUNWAY **BLAZER**

TRACK & FIELD

I
1124



I Implement Rack

Heavy-duty tubular steel. Holds 14-assorted discus, 14-shot puts and 14-hammers. 8" fixed semi-pneumatic wheels, 5" swivel solid rubber casters on front. 36"W x 36"H x 27"D at base.

1124 UPS SHIPPABLE 82 LBS.

\$590.00

J
1126CP



**BUY 8 BLOCKS & GET
★ CART FREE! ★
SAVINGS OF \$250!**

J Sprint Block & Cart Package

(1) #1126 Starting Block Cart and
(8) #1112 Sprint Starting Blocks

Strong chrome steel rail with aluminum 4-angle adjustment pedals.

These items are not sold separately. Only available in the package.

1126CP FREIGHT ONLY 2@64 LBS. & 1@90 LBS.

\$800.00

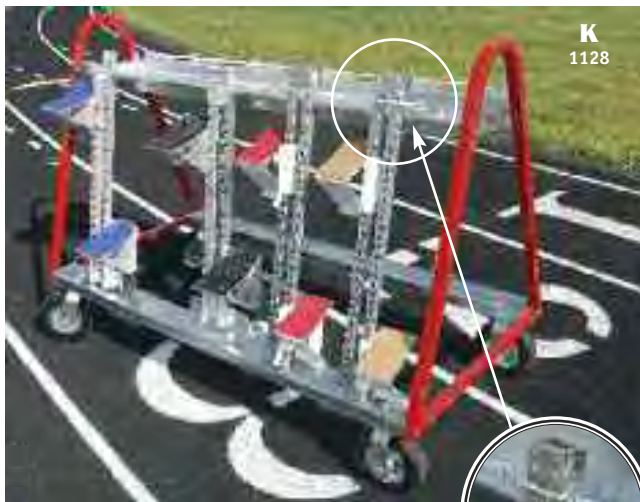

K
1128

**★ BUNGEE CORDS KEEP BLOCKS
SECURE OVER ANY TERRAIN! ★**

K Universal Starting Block Cart

Capable of transporting 10-starting blocks. Steel construction. Top tray to place block shoes or other smaller equipment. 4-8" cushion heavy-duty tires for easy pushing from swivel end on grass or hard surfaces.

1128 UPS SHIPPABLE 1@85 LBS. + AH, 1@27 + AH

\$638.00



L
1127

L Starting Block Cart

Capable of holding 12-starting blocks. Steel construction. Large base tray to store shoes. 3" swivel rubber wheel casters.

1127 UPS SHIPPABLE 1@58 LBS. + AH

\$255.00

**EVERTUFF® THE MOST
★ ECONOMIC SOLUTION ★
TO OLD, WORN-OUT RUNWAYS.**

M Evertuff® Roll-Out Runway

Spike resistant, all weather. Made from recycled black rubber with speckled color variations and with polyurethane binder. For use on concrete, asphalt, or on a level smooth surface. 50-ft. minimum order.

1600S 10mm 3/8" thickness per 30" wide	\$5.20 / linear foot
1601S 10mm 3/8" thickness per 36" wide	\$6.80 / linear foot
1602S 10mm 3/8" thickness per 42" wide	\$7.90 / linear foot
1603S 10mm 3/8" thickness per 48" wide	\$9.00 / linear foot



M
1600S
1601S
1602S
1603S

THE LARGEST SELECTION OF SPIKES
★ AVAILABLE ANYWHERE! ★

Traditional Steel Spikes
 heat treated, zinc plated



---- blank 1/8" camlock 1/8" needle 1/8" pyramid 1/4" needle 1/4" pyramid 3/16" pyramid 3/16" needle 3/8" needle 3/8" pyramid 1/2" pyramid 5/8" pyramid

A 7199 **A Javelin Spikes**
 1" in length.
 Retail Packaged
 20-Spikes Per Bag
 7199 \$9.00



B **Steel Track Spikes With Wrench**
 A 3-way key wrench in a clamshell for attractive retail display.
 Retail Packaged 12-Spikes Per Bag

7786	1/8" needle	\$3.60
7789	1/8" pyramid	\$3.60
7746	1/4" needle	\$3.60
7749	1/4" pyramid	\$3.60
7769	3/16" pyramid	\$3.60
7767	3/16" needle	\$3.60
7737	3/8" needle	\$3.60
7739	3/8" pyramid	\$3.60
7729	1/2" pyramid	\$3.60
7759	5/8" pyramid	\$3.60



C **Steel Track Spikes Without Wrench***
 Packaged in poly bags properly labeled and punched for display.
 Retail Packaged 14-Spikes Per Bag

7209	---- blanks	\$3.00	7269	3/16" pyramid	\$3.00
7288	1/8" camlock	\$3.00	7267	3/16" needle	\$3.00
7286	1/8" needle	\$3.00	7237	3/8" needle	\$3.00
7289	1/8" pyramid	\$3.00	7239	3/8" pyramid	\$3.00
7246	1/4" needle	\$3.00	7229	1/2" pyramid	\$3.00
7249	1/4" pyramid	\$3.00	7259	5/8" pyramid	\$3.00

Retail Packaged 100-Spikes Per Bag

7109	---- blanks	\$13.20	7169	3/16" pyramid	\$10.70
7188	*1/8" camlock	\$19.80	7167	3/16" needle	\$10.70
7186	1/8" needle	\$10.40	7387	3/8" needle	\$11.10
7189	1/8" pyramid	\$10.40	7389	3/8" pyramid	\$11.10
7146	1/4" needle	\$10.70	7129	1/2" pyramid	\$14.00
7149	1/4" pyramid	\$10.70	7589	5/8" pyramid	\$14.00

* Requires #7184 wrench

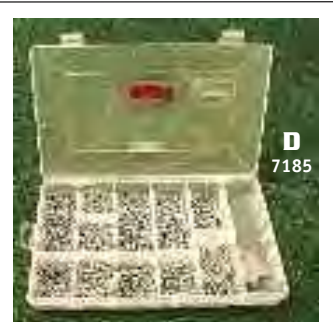

D 7185 **Steel Spike Kit With Wrench**
 All spikes are in a molded container, divided and appropriately marked. Allows the retail dealer to have all individual loose spikes available. One 3-way key wrench included.
 Retail Packaged 1500-Spikes Per Kit

200 Spikes	1/8" pyramid
400 Spikes	1/4" needle
400 Spikes	1/4" pyramid
200 Spikes	3/16" needle
100 Spikes	1/2" pyramid
100 Spikes	3/8" needle
100 Spikes	3/8" pyramid

7185 UPS SHIPPABLE 5 LBS. \$139.00

STEELEX™
 case-hardened, hex base steel spikes™

Hex base makes it the easiest spike to install and remove ever made. Case-hardened steel with a black zinc plated process gives it extreme durability for extended life.

E **1/8" Steel Hex**
 7885 20-Spikes Per Bag \$4.10
 7485 100-Spikes Per Bag \$11.00

F **3/16" Steel Hex**
 7865 20-Spikes Per Bag \$4.10
 7465 100-Spikes Per Bag \$11.00

G **1/4" Steel Hex**
 7845 20-Spikes Per Bag \$4.10
 7445 100-Spikes Per Bag \$11.00

H **3/8" Steel Hex**
 7835 20-Spikes Per Bag \$4.10
 7435 100-Spikes Per Bag \$11.00

I **1/2" Steel Hex**
 7825 20-Spikes Per Bag \$4.50
 7425 100-Spikes Per Bag \$14.60

Attractive retail packaged display poly bags available in 20-Spike & 100-Spike QTY's!

★ FOOTBALL CLEATS ★

	<p>K 3520</p> <p>3/8" K Poly Football</p> <p>3520 100-Cleats Per Bag \$12.00 Black only ***</p>	<p>L 3510</p> <p>1/2" L Poly Football</p> <p>3510 100-Cleats Per Bag \$13.00 Black only</p>
<p>J Football Cleats - Retail Packaged 14-Cleats Per Bag Poly bagged, properly labeled, and punched for display.</p> <p>3351 1/2" poly* football (without wrench) \$2.70 3353 1/2" nylon steel tip football (without wrench) \$3.00</p>	<p>N 3530</p> <p>1/2" N Nylon Steel Tip Football</p> <p>3530 100-Cleats Per Bag \$15.00 Black only **</p>	<p>O 3550</p> <p>3/4" O Poly Football</p> <p>3550 100-Cleats Per Bag \$17.00 Black only</p>
<p>M</p> <p>3354CS 3358CS</p> <p>M Football Replacement Cleats With Wrench Retail Packaged 14-Cleats Per Bag</p> <p>3354CS 1/2" poly* football (with wrench) \$3.60 3358CS 1/2" nylon steel tip football (with wrench) \$3.90</p>		

★ SOCCER CLEATS ★

	<p>Q 3700</p> <p>1/2" Q Poly Soccer</p> <p>3700 100-Cleats Per Bag \$13.50 Black only **</p>	<p>* Polyurethane material is more durable than nylon. ** 10.40 hardness on the Calvin Scale will not burr. *** For synthetic turf fields.</p>
<p>P Soccer Cleats - Retail Packaged 12-Cleats Per Bag Poly bagged, properly labeled, and punched for display.</p> <p>3370 1/2" poly* soccer (without wrench) \$3.10</p>		

★ WRENCHES ★

<p>R 3580</p> <p>R Wrench for Football & Soccer Cleats For fast cleat removal and installation.</p> <p>3580 \$1.15</p>	<p>S 7182</p> <p>S Pro-Wrench Great for recessed spike shoes and standard shoes. Does not work with the #7188 camlock spike, or hex-based spikes.</p> <p>7182 \$5.00</p>	<p>T 7184</p> <p>T 3-Way Key Wrench Economical solution for easy spike removal or installation. Works with all Blazer track spikes.</p> <p>7184 \$2.10</p>
<p>U 7180 • 7180T</p> <p>U Universal Spike Ratchet Interchangeable socket head for both traditional and Stealex spikes.</p> <p>7180 UPS SHIPPABLE 1 LB. \$10.50 Replacement Tip for Ratchet Wrench 7180T \$3.60</p>	<p>V 7183 • 7183BT</p> <p>V T-Handle Spike Wrench Heavy duty wrench for quick spike removal or installation. Wrench does not work with the #7188 camlock spike or hex-based spikes.</p> <p>7183 \$10.00 Replacement Black End for T-Handle wrench 7183BT \$2.50</p>	



A
4980



B
4990

EASY TO READ NUMBERS!

A) Lap Counter With Stand & Bell

Keeps competitors and spectators informed. Easy-to-read numbers are mounted in an aluminum frame and can be changed with the flip of a lever. Both units contain ten numbers from 0-9. Sturdy, lightweight and easily moved with mounted wheels.

4980 UPS SHIPPABLE, 1@3 LBS. + AH 1@37 LBS. **\$430.00**

B) Performance Indicators

Up to 5-digits for displaying performance. Aluminum upper construction, with swiveling top. All steel base for added stability. Mounted wheels make transporting easy.

4981 3-Digit UPS SHIPPABLE 1@16 LBS., 1@26 LBS., 1@5 LBS. + AH **\$450.00**

4990 4-Digit UPS SHIPPABLE 1@21 LBS., 1@26 LBS., 1@5 LBS. + AH **\$562.00**

4991 5-Digit UPS SHIPPABLE 1@24 LBS., 1@26 LBS., 1@5 LBS. + AH **\$580.00**

4979 Performance Indicator Pkg **\$3,108.00**

INCLUDES: 1-4981, 4-4990 & 1-4991 FREIGHT



G
2600

\$100 FREIGHT

G) Track Judges Stand

Seats 10-people or 20-people can stand. Five rows of 48" long steps. Handrail for top three levels. Rail support along the back for safety. Red enamel finish, with galvanized seats, footrests, & backrest. Easy mobility provided by wheels 8" diameter on back.

2600 239 LBS./PR. 2-BOXES - FREIGHT ONLY **\$1,095.00**



C
4950B
4950S

C) Portable Score Unit
8" w x 13" h digital unit. Practical, portable, and simple to use.

4950B Black **\$80.00**
UPS SHIPPABLE 2 LBS.

4950S Scarlet **\$80.00**
UPS SHIPPABLE 2 LBS.

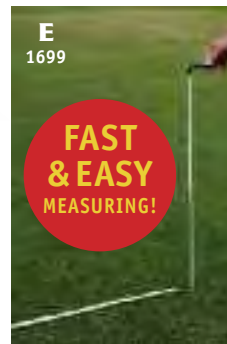

E
1699

FAST & EASY MEASURING!

E) Measuring Cane

Attach end of measuring tape to tip of cane for fast and easy measuring.

1699 **\$16.00**
UPS SHIPPABLE 4 LBS.



D
6112

D) Table Scorer with Handle
Table top scorer with 7" numbers printed on one side. Period indicators. Folds flat for easy storage with a built-in handle. 24" w x 12" h. Scores 0 to 99.

6112 UPS SHIPPABLE 6 LBS. **\$50.00**



F
1300

F) Field Markers

4" diameter steel, chalkboard-green disc. Names and numbers are easy to remove and write again. Speed up meets by marking every throw.

1300 Individual **\$3.40/ea**
UPS SHIPPABLE 1 LB.

1300S Set of 12 **\$39.00/set**
UPS SHIPPABLE 4 LBS.



H
1303

★ 5-BRIGHT COLORS! ★

H) Runway Marker Set

For synthetic surface disc. Made of solid steel construction.

1303 UPS SHIP 6 LBS. **\$19.00/set**

I) Field Tapes

Open design provides lightweight durability. Meters on one-side, feet/inches on the other.

1700 UPS SHIP 2 LBS. **\$10.00**
Fiberglass Field Tape
50'/15 meters

1710 UPS SHIP 2 LBS. **\$13.50**
Fiberglass Field Tape
100'/30 meters

1720 UPS SHIPPABLE 3 LBS. **\$18.00**
Fiberglass Field Tape - 165'/50 meters

1730 UPS SHIPPABLE 3 LBS. **\$24.00**
Fiberglass Field Tape - 200'/60 meters

1740 UPS SHIPPABLE 4 LBS. **\$31.00**
Fiberglass Field Tape - 300'/90 meters

1750 UPS SHIPPABLE 4 LBS. **\$34.00**
Steel Open Reel Field Tape - 100'/30 meters

1753 UPS SHIPPABLE 10 LBS. **\$89.00**
Steel Open Reel Field Tape - 330'/100 meters



I
FIELD TAPE

starts at zero
4"
0"

Please contact your dealer for your final price.

JUDGING EQUIPMENT **BLAZER**

TRACK & FIELD

J
2460
2470

LIMITED LIFETIME GUARANTEE!

[J] ALFA Blank Pistols
The Alfa 32/22 revolvers are rugged and reliable with bright orange grips made of high impact polymer and the orange cap on the barrel is a reminder that the revolver is not a firearm. The six shot swing out cylinder allows easy loading and unloading. A lanyard ring is included for security. Comes complete with a carrying case and cylinder cleaning brush. Winchester .32/.22 blank ammunition is recommended.

2460	22-Cal.	UPS SHIP 2 LBS.	\$268.00
2470	32-Cal.	UPS SHIP 2 LBS.	\$268.00



K
2425

[K] HQ Starter Blank Revolver
EASY TO LOAD! High quality, built for years of use! Double/Single action revolver. The cylinder swings out to insert crimps and swing closed. Comes with a lockable padded case and instructions. Holds 6-Rounds of 6mm long crimps only. Starter not recommended to use with 22 blanks. **Warranty is void if 22 blanks are used.**

CALL FOR CURRENT SHIPPING REGULATIONS * ON STARTING PISTOLS & BLANKS. *

2425	Starters Pistol	UPS SHIPPABLE 3 LBS.	\$179.00
2427	6mm Long Crimps for #2425 only.	100 per box.	\$25.00



L
2450

[L] Deluxe Import Starters Pistol with Case
Built for frequent use. Larger size for better feel. Blocked barrel and tranfer bar provide tremendous safety. Swing out cylinder holds 5-209 primers. Includes foam-lined hard-shell case.

2450-209	Primer		\$157.00
----------	--------	--	-----------------

UPS SHIP 3 LBS.



M
2586

[M] Starter Sleeve
Made of water resistant orange nylon. Elastic at both ends.

HEARING PROTECTION RECOMMENDED WHEN USING ANY STARTER PISTOL!

2586	\$10.00
------	----------------

UPS SHIPPABLE 1 LB.



N
2320, 2222, 2222C, 2321

[N] Blank Ammo
50-cartridges per box. Ship weight 1/2 lb.-non-hazardous.*

🇺🇸	2320	Winchester 22 Caliber Heavy smoke	POR
🇺🇸	2222	Winchester 22 Caliber Medium smoke	POR
🇺🇸	2222C	Winchester 22 Caliber Blanks - Case of 20	POR
🇺🇸	2321	NEW! Gator 32 Caliber Blanks Heavy Smoke	POR

*Prices are subject to change according to current market.



O
209P

[O] 209 Primers
For use with the #2450 Deluxe Import Starting Pistol. 100-per box. No smoke or flash. Great for practice and recall.

🇺🇸	209P		\$7.50 / box
----	------	--	---------------------

UPS SHIPPABLE 1 LB.



P
2585

[P] Red & White Foul Flags
Helps officials broadcast fouls in field and running events.

2585	\$13.00
------	----------------

UPS SHIPPABLE 1 LB.



Q
2451

[Q] Rugged Nylon Belt Holster
Durable, comfortable & secure. Velcro® safety strap firmly holds pistol in place, yet permits easy removal.

🇺🇸	2451		\$23.00
----	------	--	----------------

UPS SHIPPABLE 1 LB.



T
2452

[T] Gun Cleaning Kit for 32 or 22-Cal.
INCLUDES:

- 1-Steel rod with swivel handle
- 1-Accessory adapter
- 1-Double end nylon bristle gun brush
- 1-Phosphor bronze bore brush
- 1-Cotton bore mop

For best results, scrub gun thoroughly with hot, soapy water before using kit. Slotted patch holder. Formula 3-gun conditioner. Cotton cleaning patches. Silicone gun cloth.

🇺🇸	2452	Non Hazardous	\$40.00
----	------	---------------	----------------

UPS SHIPPABLE 1 LB.



R
2587

[R] Yellow & White Umpires Flag
Helps umpires signal infractions and irregularities during a race.

2587	\$13.00
------	----------------

UPS SHIPPABLE 1 LB.



S
1302

[S] Digital Implement Scale
55 LB capacity. Accurate to 0.1oz. Easy to read. Extra large "easy press" buttons. Powered by 4 "C" cell batteries (not included). Detachable faceplate.

30 YEAR WARRANTY!

1302	UPS SHIPPABLE 9 LBS.	\$79.00
------	----------------------	----------------

★ WEIGHS ALL SIZES OF IMPLEMENTS! ★



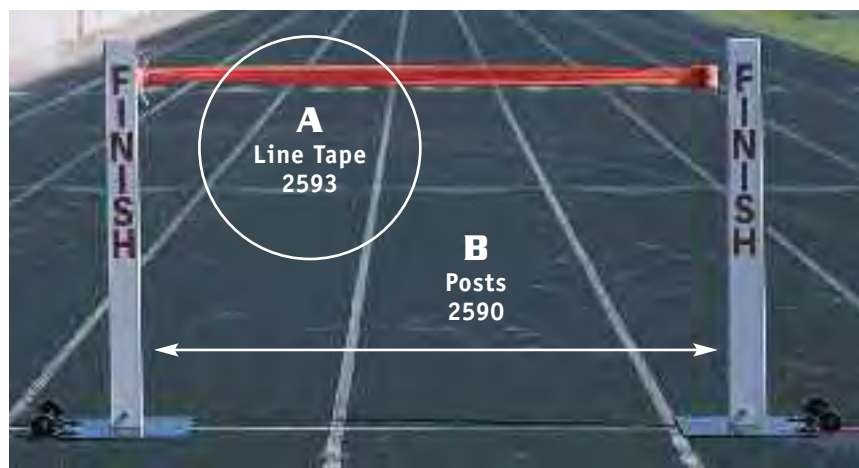

A Finish Line Tape

Bright red foam gauze tape that is light-weight and easy to break, 50-yard roll.

2593 \$4.00
UPS SHIPPABLE 1 LB.

B Finish Line Posts

Class up the finish line with a steel post and base. Will hold tape or yarn. Comes with a wheel kit for easy portability. Highly visible bold letters.

2590 \$402.00/pr
UPS 2 BOXES 1@45 LBS., 1@37 LBS.

C Plastic Baton Great for practice.

1000 Yellow Only \$2.70

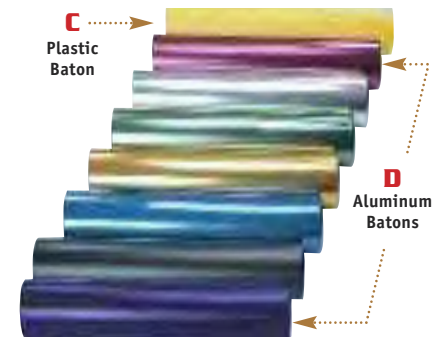

★ 7-COLORS TO CHOOSE FROM! ★

D Aluminum Batons	Color	Price
1002	Blue	\$3.30
1003	Green	\$3.30
1004	Red	\$3.30
1005	Gold	\$3.30
1006	Silver	\$3.30
1007	Black	\$3.30
1008	Purple	\$3.30



E Competitor's Numbers

Large and easy-to-read numbers. Printed on heavy paper to ensure durability.

Sets \$15.00/ea

Please specify the number needed when ordering.

0900 COMPETITOR'S #01-#100
Size: 5-3/4" H X 11-1/4" W

0910 COMPETITOR'S #101-#200
Size: 5-3/4" H X 8-3/4" W

0920 COMPETITOR'S #201-#300
Size: 5-3/4" H X 8-3/4" W

0930 COMPETITOR'S #301-#400
Size: 5-3/4" H X 11-1/4" W

0940 COMPETITOR'S #401-#500
Size: 5-3/4" H X 11-1/4" W

0950 COMPETITOR'S #501-#600
Size: 5-3/4" H X 11-1/4" W

UPS SHIPPABLE 1 LB.



F Hip Numbers

Bulk roll of 250 numbers. 3-1/2" numbers on pressure sensitive paper with easy peel-off backing is flexible and sticks to all uniforms. A must for photo finish timing.

Bulk Roll \$18.00/ea

Each Number • Set of 250

09591 HIP #1	095910 HIP #10
09592 HIP #2	095911 HIP #11
09593 HIP #3	095912 HIP #12
09594 HIP #4	095913 HIP #13
09595 HIP #5	095914 HIP #14
09596 HIP #6	095915 HIP #15
09597 HIP #7	095916 HIP #16
09598 HIP #8	095917 HIP #17
09599 HIP #9	095918 HIP #18

UPS SHIPPABLE 1 LB.



G Hip Numbers

Set of 25. 3-1/2" number on pressure sensitive paper with easy peel-off backing is flexible and sticks to all uniforms. A must for photo finish timing.

0960 \$20.40

HIP #1-#9 • Set of 25
UPS SHIPPABLE 3 LBS.

0961 \$20.40

HIP #10-#18 • Set of 25
UPS SHIPPABLE 3 LBS.

0962 \$23.00

HIP #19-#30 • Set of 25
UPS SHIPPABLE 3 LBS.



EASY PEEL OFF BACKING!

H Cross Country Large Race Hip Numbers

Roll of #'s 1-200. Numbers are printed on pressure sensitive paper with easy peel-off backing. Flexible and sticks to all uniforms.

0965 \$34.00

HIP #1-#200 • One Roll
UPS SHIPPABLE 1 LB.

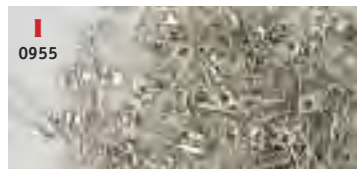

I Safety Pins

1" nickel plated steel pins for competitor's number's. Comes packed 144 each.

0955 UPS SHIPPABLE 1 LB. \$5.50

J Hip Number Dispenser

Holds 9-rolls of numbers with EASY tear off bar.

0969 UPS SHIPPABLE 9 LBS. \$70.00

★ EASY TO STORE & MOVE ★ HIP NUMBERS AT YOUR MEET!



NEW!



L Heavy-Duty Cones

Fluorescent Orange extra durable open top cones. Weighted rubber bottoms, yet cones remains soft & crushable.

4106 6" Cone	UPS SHIPPABLE 1 LB.	\$11.50
4112 12" Cone	UPS SHIPPABLE 2 LBS.	\$16.90

★ BREAKS EASILY! ★

M Finish Line Yarn
Soft, 100% 4 lb. pull-test wool yarn. Breaks easily, eliminating burns and cuts.

2592 150 yards \$8.00
UPS SHIPPABLE 1 LB.

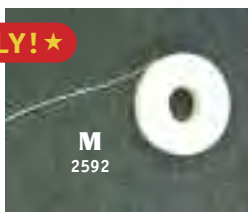



N **Aluminum Measuring Wheel with Stand**
1786
 Ergonomic plastic handle for a comfortable grip while measuring. 3-section telescoping shaft, magnified counter and reset button to clear measurements. Axle drive system for accurate measurements to the nearest inch up to 10,000 ft. Durable 11.5" plastic wheel to use for optimal use outdoors.

1786	\$83.00
Inches & Feet	
UPS SHIPPABLE 3 LBS.	



O **Professional Measuring Wheel**
1787
 Made with steel construction that is durable and built to last! Features a large magnified counter that is easy and fast to read, wheel brake for more accurate measuring, and a folding handle for convenience. Wheel diameter is 15-1/2" inches, measures to 1000,000 ft in FT/IN.

1787	\$191.00
Inches & Feet	
UPS SHIPPABLE 11 LBS.	



P **Measuring Wheel in Feet/Inches**
1790
1791
 Wide neoprene tire provides excellent traction. Precision totalizer automatically records up to 100,000 feet. Automatic brake prevents accidental backtracking. Built-in stand keeps wheel in upright position. Wheel calibration to 1/2" on one side, 1/5 of a foot on the other. Plated steel disc construction. All steel construction. 4' circumference, 15-1/2" diameter. 29" long handle.

1790 Inches & feet	UPS SHIPPABLE 8 LBS.	\$223.00
1791 Metric only	UPS SHIPPABLE 7 LBS.	\$235.00

★ **SAVE MONEY WHEN YOU PURCHASE THE COMPLETE KIT IN 1-EASY STEP!** ★

Q COMPLETE ★ CROSS COUNTRY KIT ★



R 2905 Chute Kit
U 2903 Directional Flags & Posts
S 2902 Pennant Post
V 2901 Pennants on a Rope
W 2904 Nylon Carrying Bag

YOUR BEST VALUE!

Q COMPLETE ★ CROSS COUNTRY KIT - INCLUDES:

- #2904 ... • 1-Easy to Carry Nylon Bag
- #2902 ... • 24-Pennant posts
- #2901 ... • 2-120' Pennants on a rope
- #2903 ... • 9-Directional flags w/posts
 - 3-Red ● 3-Yellow ● 3-Blue

Pennant posts are an H section, molded of UV resistant polypropylene. Directional posts are 3/4" tubular steel 80-1/2"L. Directional flags are 15" x 15"L. Poles are wedged to push into the ground easily. (Includes carrying bag.)

2900 UPS SHIPPABLE 44 LBS. + AH **\$440.00**

R Chute Kit - INCLUDES:

- #2902 ... • 24-Pennant posts
- #2901 ... • 2-120' Pennants on a rope

Chute Kit pennant posts are a strong H-section molded post. Post size: 48"L.

2905 UPS SHIPPABLE 24 LBS. **\$254.00**

S Pennant Post
 Have a strong H section post molded of UV resistant poly-propylene. Metal stake end of post easily inserts into hard ground. Specifications are 48"H (Includes post only.)

2902 \$11.00/ea
 UPS SHIPPABLE 2 LBS.

T 2906S
NEW!

★ **STURDY BASE★ ALL SURFACES!**

T Steel Hard Surface Pennant Post & Stand
 Set of ten 19" round base with 48" pennant post. Designed to hold pennants on a rope over synthetic turf and hard surfaces. (Post and stand only.)

NEW! 2906 \$19.90/ea
 UPS SHIPPABLE 6 LBS.

NEW! 2906S \$179.00
 Set of 10 UPS SHIP 52 LBS.

U Directional Posts Base Features



U Directional Flags with Posts - INCLUDES:

- 3-Red flags w/posts ● 3-Yellow flags w/posts ● 3-Blue flags w/posts

Directional posts are 3/4" tubular steel 80-1/2"L.

2903 Suggested school price **\$134.00**
 (Includes flags & posts only) UPS SHIPPABLE 16 LBS. + AH

★ **SPECIAL COLORS AVAILABLE!** ★ **V**

V Pennants On A Rope
 120'L bright colored pennants. (Includes pennants only.)

2901 UPS SHIP 2 LBS. **\$26.00**



W Nylon Carrying Bag
 Durable nylon fabric carrying bag, with easy zipper closure & carrying strap. Size 20"w x 7"d. (Includes bag only.)

2904 \$60.00
 UPS SHIP 6 LBS.

★ **EASY TO CARRY ★ NYLON BAG W/ZIPPER!** ★ **W**



2904



A
1808

A Pit Shovel
Head is made of 16-gauge steel with bent-forward steps for added comfort. 48" fiberglass handle. Square head is perfect for shoveling sand!

1808 \$29.00
UPS SHIPPABLE 6 LBS. + AH



B
1804
1794

B Telescopic Rake
Knocks down for easy storage in lock box. High-grade aluminum alloy head. Rounded teeth are non-gouging. Double lock telescopic handle easily adjusts from 39" to 70".

1804 24" Rake \$103.50
UPS SHIPPABLE 5 LBS.
1794 36" Rake \$105.00
UPS SHIPPABLE 5 LBS.



C
1810

C Loop Hoe
Double-edged knife rock back and forth for efficient push and pull motion. 60"x 1-1/8" D. A sturdy blue powder-coated aluminum handle with 6" non-slip vinyl grip.

1810 \$45.00
UPS SHIPPABLE 6 LBS. + AH



D Field Rake

Highly recommended for professional use. Designed to specifications of professional baseball ground crews. Great for track pit maintenance. Extended strike edge engineered specifically for grading. Round teeth offer smooth non-gouging raking action. 66" powder coated handle with vinyl grip.

1801 24" UPS SHIPPABLE 4 LBS. + AH \$57.00
1802 30" UPS SHIPPABLE 5 LBS. + AH \$66.00
1795 36" UPS SHIPPABLE 5 LBS. + AH \$70.50
1803 48" UPS SHIPPABLE 6 LBS. + AH \$75.00
1809 36" Sport Rake \$64.00
UPS SHIPPABLE 5 LBS. + AH

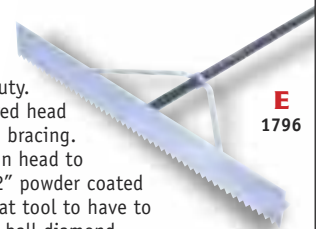

E 36" Light Lute

Light weight, heavy duty. Combines an engineered head w/strong wrap-around bracing. Solid aluminum plug-in head to handle connection. 82" powder coated aluminum handle. Great tool to have to smooth landing pit or ball diamond.

1796 UPS SHIPPABLE 6 LBS. + AH \$64.50



F 36" Roller Squeegee

Heavy duty aluminum frame construction. Stainless steel axles ensure the roller stays secure. Absorbent roller holds up to 1-gallon of water.

1798 Non-Absorbent Roller \$130.00
UPS SHIPPABLE 8 LBS. + AH
1807 PVA Absorbent Roller \$147.00
UPS SHIPPABLE 8 LBS. + AH

G
1805
1806

★ BENT OR STRAIGHT HANDLE OPTION! ★



G 24" General Purpose Broom

This 24" general purpose broom is an excellent choice for base path and infield dressing. Professional grounds keepers flip the broom over for a final dressing of the base paths. Available with either a 60" ergonomic bent powder-coated aluminum handle or a 60" straight powder-coated aluminum handle.

1805 Bent Handle UPS 6 LBS. + AH \$64.50
1806 Straight Handle UPS 6 LBS. + AH \$64.50



H
1793

★ EXTRA WIDE 84" HEAVY-DUTY BROOM! ★

H Monster Broom

84" wide. Drag it on the infield or push it on the tennis court. Made with heavy duty aluminum. Two rows of bristles that are removable for easy replacement or for adjusting broom stiffness.

1793 \$209.00
UPS SHIPPABLE 16 LBS. + AH



I
1800

I 36" Screening Rake

This rake is specially designed for sifting, grading and screening. It is an excellent tool when you need to sift or screen stones and debris from sand or fine soil. It has a 66" powder-coated aluminum handle with 5" vinyl grip and strong wrap around bracing provide for maximum durability and comfort.

1800 \$79.00
UPS SHIPPABLE 5 LBS. + AH

Please contact your dealer for your final price.

VOLLEYBALL SYSTEMS **BLAZER**

VOLLEYBALL

J ACE POWER ★ ALUMINUM 2-POLE VOLLEYBALL SYSTEM



**MEETS
NCAA®
USAV NFHS
RULES**

Lightweight  **Made in USA**

EASY TO TRANSPORT & ADJUST



Rope Ratchet	Ground Sleeve	K ACE Super Pro Net	Aluminum Roller	Aluminum Pole	L Judges Stand
					

★ FREE SHIPPING! ★ WITH THE PURCHASE OF ANY COMPLETE ACE SYSTEM!*
*For a limited time.

ACE POWER VOLLEYBALL POLES

These poles are UPS Shippable!



J ACE POWER ★ Aluminum 2-Pole System - With Ground Sleeves
INCLUDES: • 2-Aluminum poles • 1-Rope ratchet • 2-Velcro® Collars w/1D Ring
 • 2-Ground sleeves* • 1-Worm gear

Telescopic poles adjusts easily to official heights for:
MEN'S (7' 11-5/8") ★ WOMEN'S (7' 4-1/8") ★ JUNIORS (7') ★ YOUTH (6'6").
 Constructed of 3.5" O.D. lower powder coated aluminum tubing. Winch straps come with hooks for easy net attachment. Lower net collars are Velcro® closures. Poles are constructed of high strength extruded aluminum with a combined weight of 69 lbs.

 **6067 With Ground Sleeves** UPS SHIPPABLE 97 LBS. + AH **\$1,950.00**

ACE POWER ★ Add a Court - INCLUDES:
 • 1-Aluminum center pole • 1-Rope ratchet • 1-Collar
 • 1-Ground sleeve* • 1-Worm gear

Adds 3rd pole to 2-Pole Blazer System®, to make a 3-pole side-by-side 2-court set up.

 **60673 With Ground Sleeve** SHIP 46 LBS. **\$1,271.00**
 **60673NGS* Without Ground Sleeve** SHIP 40 LBS. **\$1,175.00**
*Please specify existing ground sleeve I.D., depth and center-to-center when ordering.

ACE POWER ★ Aluminum 2-Pole System - Without Ground Sleeves
INCLUDES: • 2-Aluminum poles • 1-Rope ratchet • 1-Worm gear

 **6067NGS* Without Ground Sleeves** UPS SHIPPABLE 86 LBS. + AH **\$1,764.00**
*Please specify existing ground sleeve I.D., depth and center-to-center when ordering.



K Super Pro Net
 Extra strong #36 nylon flexabar treated netting. Constructed with a 41' x 1/4" top rope reinforced with KEVLAR® brand fiber that will not kink like steel cabled nets and 38' bottom. Net connects to the worm gear for safe and easy installation. With web strap for easy tensioning.

 **6054WS** UPS SHIPPABLE 7 LBS. **\$317.00**

★ SAVE MONEY! ★ PURCHASE THE ENTIRE SYSTEM IN 1-EASY STEP! ★

COMPLETE ACE POWER ★ Aluminum 2-Pole System - INCLUDES:

#6067	• 2-Aluminum poles	• 2-Ground sleeves*	• 1-Worm gear
#6054WS	• 1-Super Pro net	• 1-Rope ratchet	• All padding for cables, poles & judges stand
#6060	• 1-Pair Quick N' EZ antennas		
#6015	• 1-Folding judges stand with wheels		

 **6067CP With Ground Sleeves** 205 LBS. FREIGHT ONLY **\$3,465.00**
 **6067CPNGS* Without Ground Sleeves** 195 LBS. FREIGHT ONLY **\$3,290.00**
*Please specify existing ground sleeve I.D., depth and center-to-center when ordering.



L Volleyball Judges Stand with Wheels
 Folds together providing compact storage. Free standing sturdy 4-leg design works with any system. Made of 1-1/4" zinc plated steel tubing. Legs have protective rubber tips to prevent floor marring. Traction strips on platform & steps for safety. 80"H x 32"W x 44"D. At base, platform is 25"W x 26"D.

 **6015** 79 LBS. FREIGHT ONLY **\$500.00**

A POWER ★ ALUMINUM VOLLEYBALL POLE SYSTEMS

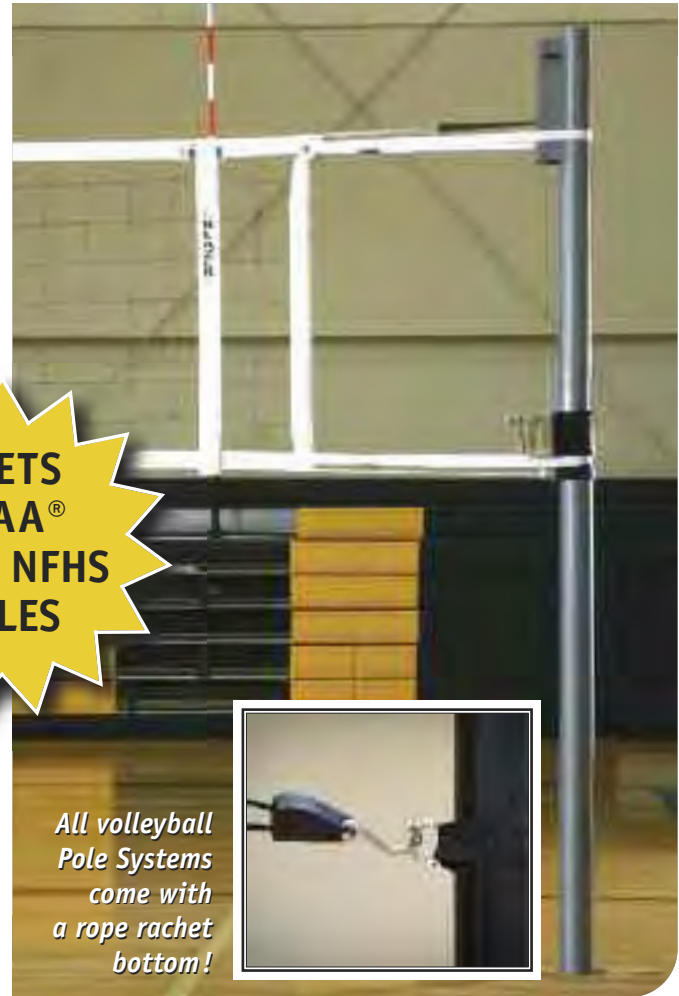
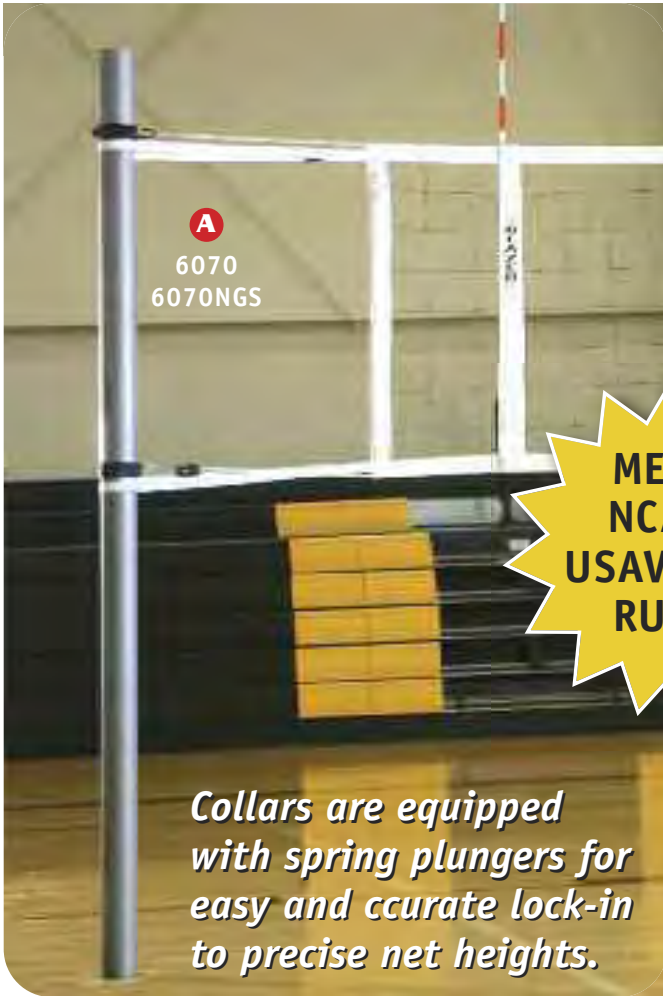

**MEETS
NCAA®
USAV NFHS
RULES**

Collars are equipped with spring plungers for easy and accurate lock-in to precise net heights.

All volleyball Pole Systems come with a rope ratchet bottom!

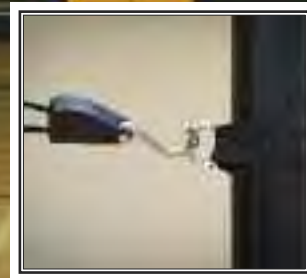

★ BLAZER VOLLEYBALL SYSTEMS ARE THE ★ LONGEST LASTING ★

A POWER ★ Aluminum Volleyball Pole Systems - With Ground Sleeves

- INCLUDES: ● **Color-Silver** ● 2-Aluminum poles ● 1-Rope ratchet
● 2-Ground Sleeves ● 1-Worm gear

Adjusts easily to official heights for:

MEN'S (7' 11-5/8") ★ WOMEN'S (7' 4-1/8") ★ JUNIORS (7').

Constructed of 3.5" O.D. aluminum tubing with a 1/4" wall thickness. Net cable connects to the worm gear for safe and easy tightening and loosening. Winch straps come with hooks for easy net attachment. Powder coated. All collars are equipped with spring plungers for positive collar height placement.

6070 ALUMINUM 2-Pole System - With Ground Sleeves **\$1,550.00**
Requires 1-pair of pole pads for a single court set-up. 98 LBS. FREIGHT ONLY

POWER ★ Steel Volleyball Pole Systems - With Ground Sleeves

- INCLUDES: ● **Color-Red** ● 2-Steel poles ● 1-Rope ratchet
● 2-Ground Sleeves ● 1-Worm gear

Adjusts easily to official heights for:

MEN'S (7' 11-5/8") ★ WOMEN'S (7' 4-1/8") ★ JUNIORS (7').

Constructed of 3.5" O.D. steel tubing. Net cable connects to the worm gear for safe and easy tightening and loosening. Winch straps come with hooks for easy net attachment. Powder coated. All collars are equipped with spring plungers for positive collar height placement.

6050 STEEL 2-Pole System - With Ground Sleeves **\$1,350.00**
Requires 1-pair of pole pads for a single court set-up. 138 LBS. FREIGHT ONLY

POWER ★ Aluminum Poles - Without Ground Sleeves

● **Color-Silver.** For a single court set-up. Does not include ground sleeves.

6070NGS* Without Ground Sleeves **\$1,364.00**

**Please specify existing ground sleeve I.D., depth and center-to-center when ordering.* 91 LBS. FREIGHT ONLY

POWER ★ Steel Poles - Without Ground Sleeves

● **Color-Red.** Same description as the #6050 except has no ground sleeves.

6050NGS* Without Ground Sleeves **\$1,164.00**

**Please specify existing ground sleeve I.D., depth and center-to-center when ordering.* 134 LBS. FREIGHT ONLY

B
666CSTD



B Custom Volleyball Standard Adaptation

To adapt the Blazer standard to fit an existing ground sleeve, specify the ground sleeve I.D. and depth when ordering. Blazer ground sleeves are 3-1/2" I.D. and are 12" deep. (Measured from the bottom of the sleeve to floor level.)

666CSTD* **\$57.00/per pole*****

C
666CNET

★ NETS ARE SOLD ON PAGE 32! ★

C Custom Volleyball Net Cable Length

To special order any other cable lengths please specify the upper and lower cable length measurements off the old net. Blazers' standard volleyball net upper cable length is 34' 6". (Which accommodates a court that has 36' 6" measurement from center of ground sleeve to center of ground sleeve.)

666CNET** **\$57.00/per net*****

No returns or exchanges on custom standards and nets once they have been adapted to your specifications.Prices are in addition to the price of the product.*

Please contact your dealer for your final price.

UNIVERSAL ★ VOLLEYBALL POLES 

VOLLEYBALL

D UNIVERSAL ★ ALUMINUM VOLLEYBALL POLE SYSTEMS

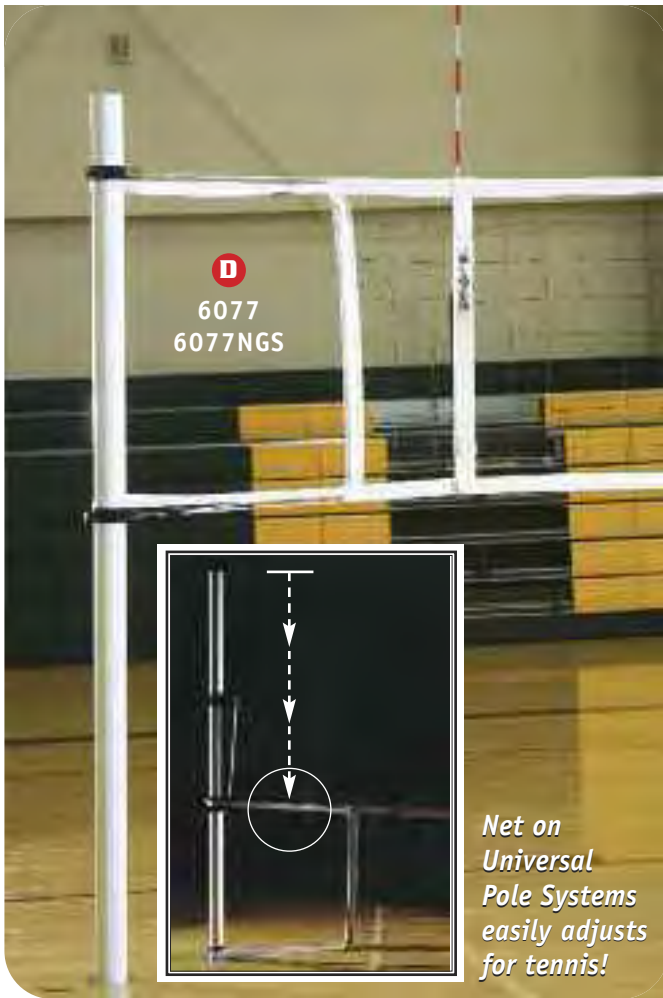

D
6077
6077NGS

Net on Universal Pole Systems easily adjusts for tennis!

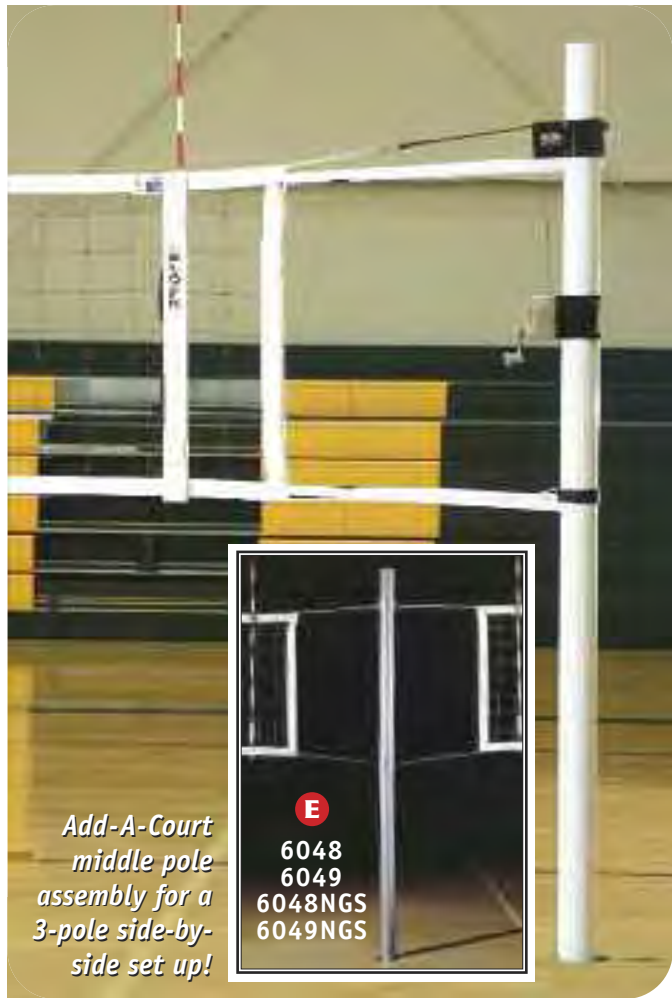

E
6048
6049
6048NGS
6049NGS

Add-A-Court middle pole assembly for a 3-pole side-by-side set up!

AND ★ EASIEST TO SET-UP ON THE MARKET TODAY! ★

D UNIVERSAL ★ Aluminum Volleyball Pole Systems - With Ground Sleeves

INCLUDES: ○ Color-Powder Coated White • 2-Steel poles • 2-Ground sleeves
• 1-Rope ratchet • 1-Worm gear

Adjusts easily to official heights for: BADMITTON (5') ★ MEN'S (7' 11-5/8")

WOMEN'S (7' 4-1/8") ★ JUNIORS (7') ★ YOUTH (6' 6") ★ TENNIS (3') ★ PICKLEBALL (3').

All collars are equipped with spring plungers for positive collar placement. Constructed of 1/4" wall thickness aluminum tubing. Net cable connects to worm gear for safe and easy tightening and loosening. Winch strap comes with hooks for easy net attachment. Poles are predrilled.

 **6077 ALUMINUM 2-Pole System - With Ground Sleeves** 103 LBS. FREIGHT ONLY **\$1,550.00**

Requires 1-pair of pole pads for a single court set-up.

 **6077NGS* ALUMINUM 2-Pole ONLY - Without Ground Sleeves** 94 LBS. FREIGHT ONLY **\$1,364.00**

*Please specify existing ground sleeve I.D., depth and center-to-center when ordering.

 **UNIVERSAL ★ Steel Volleyball Poles - With Ground Sleeves**

● Color-Silver. Universal Steel System has same features as above only it is constructed of 3.5" O.D. steel tubing that is zinc plated to prevent rusting.

 **6076 STEEL 2-Pole System - With Ground Sleeves** 142 LBS. FREIGHT ONLY **\$1,350.00**

Requires 1-pair of pole pads for a single court set-up.

 **6076NGS* STEEL 2-Pole ONLY - Without Ground Sleeves** 132 LBS. FREIGHT ONLY **\$1,164.00**

*Please specify existing ground sleeve I.D., depth and center-to-center when ordering.

E POWER & UNIVERSAL ★ Add-A-Court

INCLUDES: • 1-Center Pole • 1-Ground sleeve • 1-Rope ratchet • 1-Worm gear • 3-Collars
Adds 3rd pole to 2-Pole Blazer System®, to make a 3-pole side-by-side 2-court set up.

 **6048 ALUMINUM - With Ground Sleeve** 61 LBS. FREIGHT ONLY **\$1,070.00**

 **6048NGS* ALUMINUM - Without Ground Sleeve** 56 LBS. FREIGHT ONLY **\$975.00**

 **6049 STEEL - With Ground Sleeve** 79 LBS. FREIGHT ONLY **\$1,000.00**

 **6049NGS* STEEL - Without Ground Sleeve** 74 LBS. FREIGHT ONLY **\$904.00**

*Please specify existing ground sleeve I.D., depth and center-to-center when ordering.

F
6063

F Standard Worm Gear Winch

Easy crank worm gear winch allows precise net tension.

21:1 gear ratio. 2" net strap ensures no kinking or binding of net cable.

6063 **\$242.00/ea**

UPS SHIPPABLE 9 LBS.



G
6065

G Premium Worm Gear

Comes with the Ace System.

26:1 gear ratio. The best speed in the industry for a worm-gear design. Safe and easy tightening and loosening, anti back-lash. Lightweight, compact, milled construction. Handle swings out of the way.

 **6065** **\$423.00/ea**

UPS SHIPPABLE 8 LBS.



H
6082

H Ground Sleeve (Only)

2-piece all aluminum construction.

12" deep and must be cemented in. Gold anodized floor plate. Complete installation instructions included. 3-1/2" I.D., 4" O.D. Center lid swivels out of the way.

 **6082 UPS SHIP 10 LBS. \$308.00/ pr**



★ SAVE MONEY WHEN YOU PURCHASE THE COMPLETE SYSTEM IN 1-EASY STEP! ★

A COMPLETE ACE POWER ★ Aluminum 2-Pole System

INCLUDES: #6067... • 2-Aluminum poles • 2-Ground sleeves*
 #6054WS... • 1-Super Pro net • 1-Rope ratchet
 #6060... • 1-Pair Quick N' EZ antennas • 1-Worm gear
 #6015... • 1-Folding judges stand with wheels • All padding for cables, poles and judges stand

PICTURED ON PG-29

	6067CP With Ground Sleeves	205 LBS. FREIGHT ONLY	\$3,465.00
	6067CPNGS Without Ground Sleeves	195 LBS. FREIGHT ONLY	\$3,290.00

*Please specify existing ground sleeve I.D., depth and center-to-center when ordering.

COMPLETE ALUMINUM ★ Volleyball System

INCLUDES: #6070... • 2-Aluminum poles • 2-Ground sleeves*
 #6061... • 1-Competition power net • 1-Rope ratchet
 #6059... • 1-Pair Deluxe antennas • 1-Worm gear
 #6015... • 1-Folding judges stand with wheels • All padding for cables, poles and judges stand

PICTURED ON PG-30

	6075 With Ground Sleeves	218 LBS. FREIGHT ONLY	\$3,075.00
	6075NGS* Without Ground Sleeves	208 LBS. FREIGHT ONLY	\$2,889.00
	6073 With Ground Sleeves	218 LBS. FREIGHT ONLY	\$3,075.00
<small>Same as above, except with #6077 UNIVERSAL Aluminum</small>			
	6073NGS* Without Ground Sleeves	208 LBS. FREIGHT ONLY	\$2,889.00
<small>Same as above, except with #6077 UNIVERSAL Aluminum</small>			

*Please specify existing ground sleeve I.D., depth and center-to-center when ordering.

COMPLETE STEEL ★ Volleyball System

INCLUDES: #6050... • 2-Steel poles • 2-Ground sleeves*
 #6057... • 1-Deluxe net • 1-Rope ratchet
 #6060... • 1-Pair of antennas • 1-Worm gear
 #6015... • 1-Folding judges stand with wheels • All padding for cables, poles & judges stand

PICTURED ON PG-30

	6074 With Ground Sleeves	282 LBS. FREIGHT ONLY	\$2,750.00
	6074NGS* Without Ground Sleeves	272 LBS. FREIGHT ONLY	\$2,574.00
	6072 With Ground Sleeves	282 LBS. FREIGHT ONLY	\$2,750.00
<small>Same as above, except with #6076 UNIVERSAL Steel</small>			
	6072NGS* Without Ground Sleeves	272 LBS. FREIGHT ONLY	\$2,574.00
<small>Same as above, except with #6076 UNIVERSAL Steel</small>			

*Please specify existing ground sleeve I.D., depth and center-to-center when ordering.

A COMPLETE ACE ★ ALUMINUM VOLLEYBALL SYSTEM

Q 6631MAR Cable Padding

L 6060 Quick N' EZ Antennas

A 6067CP Complete Ace Power System

C 6054WS Super Pro Net

B 6611MAR Judges Stand Padding

D 6651MAR Power Pole Pads

COMPLETE VOLLEYBALL SYSTEM VALUE PACKAGES Available in Steel & Aluminum!

JUDGES STAND FOLDS UP AND WHEELS AWAY FOR EASY MOBILITY AND COMPACT STORAGE! ★

B Volleyball Judges Stand with Wheels

Folds together providing compact storage. Free standing sturdy 4-leg design works with any system. Made of 1-1/4" zinc plated steel tubing. Legs have protective rubber tips to prevent floor marring. Traction strips on platform and steps for safety. 80"H x 32"W x 44"D. At base, platform is 25"W x 26"D.

6015

	6015	79 LBS. FREIGHT ONLY	\$500.00
--	-------------	----------------------	-----------------

B Volleyball Judges Stand Padding

Wrap-around padding installs in minutes. Constructed of 600-Denier Cordura® finish vinyl with 1" foam lining. Velcros® to tubing and platform. (Fits Blazer's only.)

		6611SCA Scarlet	\$340.00
		6611KEL Kelly	\$340.00
		6611FOR Forest	\$340.00
		6611ROY Royal	\$340.00
		6611NAV Navy	\$340.00
		6611MAR Maroon	\$340.00
		6611PUR Purple	\$340.00
		6611BLK Black	\$340.00

UPS SHIPS OVERSIZED 12 LBS. + AH

★ EASY INSTALLATION! ALL BLAZER VOLLEYBALL NETS ARE WEATHER TREATED! ★

C 6054WS Super Pro Net

Extra strong #36 nylon flexabar treated netting. Constructed with a 4 1/4" top rope reinforced with KEVLAR® brand fiber that won't kink like steel cabled nets and 38" bottom. Net connects to worm gear for safe and easy installation. Web straps for easy tensioning.

FOR ACE #6067 SYSTEM

	6054WS	UPS SHIPPABLE 7 LBS.	\$317.00
--	---------------	----------------------	-----------------

D 6061 Competition Power Net

36" x 32'2" top and bottom tape. Coated steel top cable and bottom rope. Flexabar treated #24 nylon netting. All vinyl double folded and double stitched. Web straps for easy tensioning. 1/2" wood dowels. 33" long wood dowel.

	6061	UPS SHIPPABLE 10 LBS.	\$270.00
--	-------------	-----------------------	-----------------

E 6057 Deluxe Net

Coated steel top cable and bottom rope. Flexabar treated #24 nylon netting. Folded and stitched 2" top and bottom taped. 36" tall and 32' long. 33" long wood dowel.

	6057	UPS SHIPPABLE 9 LBS.	\$196.00
--	-------------	----------------------	-----------------

Competition Collegiate Net

1m x 32'2" top with bottom tape. Coated steel top cable and bottom rope. All vinyl double folded and double stitched. Web straps are for easy tensioning. 1/2" wood dowels. 36" L wood dowel.

	6064	\$286.00
--	-------------	-----------------

UPS SHIPPABLE 9 LBS.

Please contact your dealer for your final price.

VOLLEYBALL PADS ★ COMPONENTS **BLAZER**

VOLLEYBALL

F
6090

**EASY PORTABILITY
30" BASE**



**PROTECTIVE
★ EDGING PREVENTS ★
FLOOR MARRING!**

F Heavy-Duty Portable Base - Only
30" diameter and 250 pounds for indoor and outdoor use. Features protective edging that prevents marring of floor. Two 5" wheels for easy portability. To be used with #6092 component upright.

6090 \$395.00/ea
260 LBS. / EA. - FREIGHT ONLY

G
6055



★ POLY WEB TRIM ★

G Recreational Net
Used with #6092 component uprights. #15 knotted black nylon with 2" poly webbing all around. Loops on corners.

6055 \$86.00
UPS SHIPPABLE 3 LBS.

H
6092

10' FT HIGH TO ACCOMMODATE TETHERBALL!



H Component Upright
Upright consists of 2" O.D. galvanized steel. Features 2-adjustable collars so net can be placed at appropriate height. Great for P.E., badminton, volleyball, etc., and now 10' feet high to accommodate tetherball! Use with #6090 base.

6092 \$88.00/ea
20 LBS. / EA. - FREIGHT ONLY

I
6097

HELPS TO PROTECT AND PREVENT INJURIES!



I Component Upright Padding
To prevent injury, padding is available for the upright of the portable equipment.
● Color Red only.

6097 \$120.00/ea.
UPS SHIPPABLE 7 LBS. / EA.

J
6096



J Component Base Padding
Protective base pad for #6090 Portable Base.
● Color Red only.

6096 \$232.00/ea
UPS SHIPPABLE 8 LBS. / EA.

K 6059
L 6060
M 6056



K Deluxe Volleyball Antennas
Fits 36" U.S. National width net. Unique design clamps onto upper and lower cable of power net holding it firmly in place. Red & white striped.

6059 \$124.00/pr
UPS SHIPPABLE 3 LBS. + AH

L Quick N' EZ Antennas
Velcro's® up and down in seconds. No more ties, clamps or hassles! Fits 36" or 39" net. Includes 2-piece antenna and Velcro® sleeve.

6060 \$80.00/pr
UPS SHIP 3 LBS.

R6060V \$67.00/pr
UPS SHIP 1 LBS.
Replacement Velcro® Sleeves for Quick N' EZ Antennas

M Deluxe Collegiate Volleyball Antennas
Fits 1m width net length. Unique design clamps onto upper and lower cable of power net holding it firmly in place. Red & white striped.

6056 \$147.00/pr
UPS SHIPPABLE 3 LBS. + AH

N
6641
KEL



N Volleyball Center Standard Padding
Will fit other volleyball standards!
2-piece set, center volleyball standard padding. For center standard padding on side-by-side and 3-court systems. 1" thick x 6' tall, covered in 600 Denier Cordura® finish. Velcro's around the pole.

6641KEL Kelly	6641NAV Navy
6641BLK Black	6641FOR Forest
6641SCA Scarlet	6641MAR Maroon
6641ROY Royal	6641PUR Purple

UPS SHIPPABLE 10 LBS. **\$250.00/set**

WILL FIT OTHER VOLLEYBALL STANDARDS!

O
6651
BLK



O Power Pole Pads
Will fit other volleyball standards!
1-piece, wrap-around pad for power volleyball standards. 1" thick x 6' tall, covered in 600 Denier Cordura® finish. Contour fit wraps around the pole & Velcros® into itself. Sold in pairs.

**★ CUSTOMIZE ★
YOUR POWER POLE
PADDING! ***

6651KEL Kelly	6651NAV Navy
6651BLK Black	6651FOR Forest
6651SCA Scarlet	6651MAR Maroon
6651ROY Royal	6651PUR Purple

UPS SHIPPABLE 12 LBS. **\$300.00/pr**

** There is a screen charge for printing on volleyball padding. Contact your dealer for screen print pricing.*

POWER POLE PAD SCREENING SIZE IS 23" X 4"

P
6102



P Net Tensioning Rope Ratchet® Set
Easy, quick, and safe. Comes in a set of 4-rope ratchets® designed to function with a quick easy pull to tighten the ratchet and release with the push of a button. Works on most net systems.

6102 Set of 4 UPS SHIP 1 LB. \$37.00

Q
6631MAR

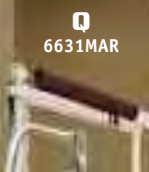

Q Volleyball Cable Padding
Split foam circular pad is covered by 600 Denier Cordura® finish vinyl with Velcro® closure. Comes in a set of 4. Each is 24"L.

6631KEL Kelly	6631ROY Royal	6631MAR Maroon
6631BLK Black	6631FOR Navy	6631PUR Purple
6631SCA Scarlet	6631FOR Forest	

UPS SHIPPABLE 2 LBS. **\$57.00/set**

A
6098



**STORES
★ EQUIPMENT ★
EASILY!**

**A Volleyball Store
All Equipment Cart**

Net winder built right in!

Sturdy all steel construction. Heavy-duty, non-marking rubber casters. Base 32" wide. Designed to support 3-sets of poles, padding and antennas. Net winder holds 2-nets.

6098 \$650.00

UPS SHIPPABLE 1 @ 81 LBS. + AH, 1 @ 12 LBS.

B Power Pole Transport Cart

Eliminate dragging poles to and from storage. Constructed of 2" square steel tubing. Hauls up to 4-poles at once. Cushioned pole rests eliminate damage to poles finish. Bottom tray provides storage of the net and other equipment. Base is 22" x 36" and rests on four swivel casters.

6099 \$410.00

1 @ 62 LBS.

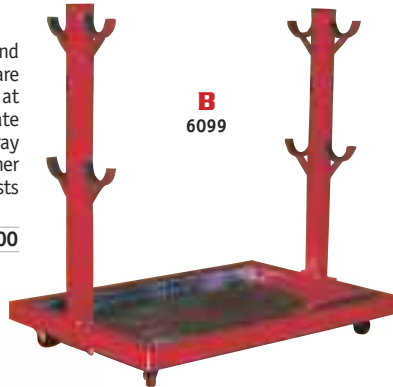

B
6099



C
6083TB

C T-Base End Standard

For installations where floor ground sleeves can't be used. Fits 3-1/2" ID volleyball standards. Heavy steel construction. Anchors to floor in two locations. (Floor anchors not included).

6083TB \$445.00 / ea

UPS SHIPPABLE 70 LBS.

D
6101

**D Net Chain
Height Gauge**
Easy to use for all common heights. Comes with storage bag.

6101 \$13.00

UPS SHIPPABLE 1 LB.



E
6111

**"THE
CART WORKS
LIKE A
DREAM!"**

E Volleyball Net Winder / Antenna Cart

"The cart works like a dream." Horizontally is the only good way to store a net without the cables and net being all tangled up! 2-locking casters. Steel frame construction with 4-non-marking heavy-duty casters. Capable of storing 4-nets and 2-pair of antennas. Nets and antennas purchased separately.

6111 UPS SHIPPABLE 1 @ 54 LBS.

\$350.00

F T-Base Standard Pole Padding

Vinyl covered foam protective pad. Each.

- 6583BLK** Black
- 6583KEL** Kelly
- 6583SCA** Scarlet
- 6583FOR** Forest
- 6583ROY** Royal Blue
- 6583MAR** Maroon
- 6583NAV** Navy
- 6583PUR** Purple

UPS SHIPPABLE 10 LBS. **\$150.00 / ea**

G T-Base Padding

Vinyl covered foam protective pad. Each.

- 6683BLK** Black
- 6683KEL** Kelly
- 6683SCA** Scarlet
- 6683FOR** Forest
- 6683ROY** Royal Blue
- 6683MAR** Maroon
- 6683NAV** Navy
- 6683PUR** Purple

UPS SHIPPABLE 12 LBS. **\$172.00 / ea**



F
6583BLK

G
6683BLK



H
6083FA

H T-Base Anchors

Spring loaded 1/2" anchors. Used for anchoring into concrete sub-floor. (Need 2-per T-base). Sold individually.

6083FA \$135.00 / ea

UPS SHIPPABLE 3 LBS.

Please contact your dealer for your final price.

TRAINING ★ OUTDOOR VOLLEYBALL **BLAZER**

VOLLEYBALL

★ **SAVE MONEY WHEN YOU PURCHASE THE ENTIRE SYSTEM IN 1-EASY STEP!** ★

I PLAY IN THE ★ GRASS OR SAND ★ WITH THIS COMPLETE OUTDOOR SYSTEM!



SONIC OUTDOOR VOLLEYBALL SYSTEM

THESE POLES ARE UPS SHIPPABLE!
WEATHER TREATED FOR OUTDOORS!

NEW!

I COMPLETE ★ SONIC OUTDOOR VOLLEYBALL SYSTEM - INCLUDES:

- #6040... • 2-Aluminum poles • 2-Ground sleeves • 1-Net ratchet
 - #6053... • 1-Weather treated 36"x 32' steel cable volleyball net
 - #6042... • 1-Grass & sand boundary marker set 30"x 60"
- Also includes: 4-bungees, 4-stakes, 1-cord winder
• 1-Mesh storage bag for net and accessories

Telescopic poles adjusts to 3-playing heights for: ★ MEN ★ WOMEN ★ JUNIORS.

Constructed of 3.5" O.D. top section, 4" O.D. bottom section.

NEW! 6040CP COMPLETE SYSTEM With Ground Sleeves	UPS SHIPPABLE 99 LBS.	\$747.00
NEW! 6040CPNGS* COMPLETE SYSTEM Without Ground Sleeves	UPS SHIPPABLE 89 LBS.	\$672.00
NEW! 6040 Poles, Ratchet and Ground Sleeves Only	UPS SHIPPABLE 85 LBS.	\$625.00
NEW! 6040NGS* Poles Only Without Ground Sleeves	UPS SHIPPABLE 79 LBS.	\$560.00

J Boundary Marker Set ★ Orange grass and sand boundary marker set 30"x 60". INCLUDES: 4-bungees, 4-stakes, and 1-cord winder

NEW! 6042	UPS SHIPPABLE 3 LBS.	\$88.50
------------------	----------------------	----------------

K Short Court Boundary Lines

To fit court 26'3" H x 52'6" L, made of black 1-1/2" w poly tape with grommets in 4-corners and center of long side. INCLUDES: 1-mesh storage bag.

NEW! 6043	UPS SHIPPABLE 3 LBS.	\$99.00
------------------	----------------------	----------------

L Replacement ★ Outdoor Volleyball Net

Vinyl binding. Size 36"H x 32'L without dowels. 36'6" x 3/16" top and bottom cables. Weather treated for outdoor. Quality USA Made.

NEW! 6053	UPS SHIPPABLE 7 LBS.	\$215.00
------------------	----------------------	-----------------

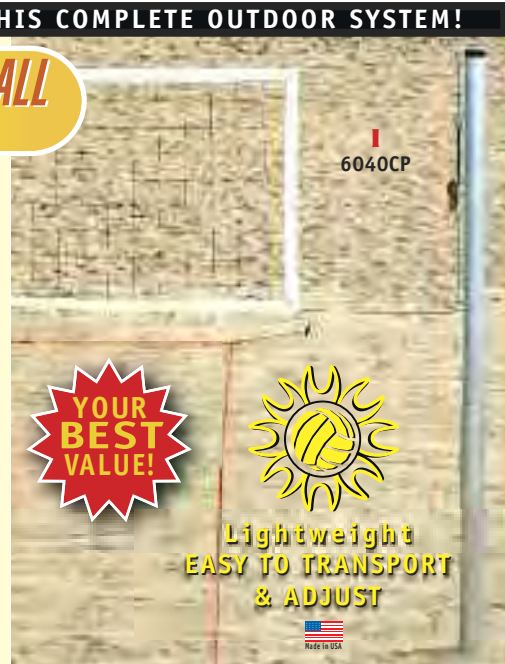

YOUR BEST VALUE!



Lightweight
EASY TO TRANSPORT
& ADJUST



J 6042



K 6043



L 6053



M 6010

Handy 24" x 12" side storage pocket. Great for clipboards, keys, crank handles and MORE!

Unique design allows balls to be placed at hip level for easy access without bending over and searching for another ball. Perfect for fast-paced line drills where the coach must also watch the athlete's technique.

Cart Holds Up to 30-Balls!

M Mega Volleyball Cart

This durable and lightweight ball cart holds up to 30-balls! With balls placed on top of removable cover, balls are at coach's hip level for easy access during fast-pace line drills. Swivel casters for smooth rolling. Liner constructed of 600 denier Cordura® finished vinyl, zinc plated steel legs. Quick-fold design provides simple and compact storage of your volleyballs.

● 6003 Red	\$192.00
● 6006 Kelly	\$192.00
● 6007 Black	\$192.00
● 6010 Royal	\$192.00

UPS SHIPPABLE OVERSIZED 23 LBS. + AH

N Flag Kit - INCLUDES:

- #4912... • 4-Nylon Linesman Flags 15" x 15"
 - 1-Easy Carry Nylon Bag
 - #4913... • 2-Nylon Linesman Flags 15" x 15"
- Aluminum handle with rubber grip. Color red.

4912 Set of 4 Flags & Carry Bag	\$33.00
--	----------------

UPS SHIPPABLE 5 LBS.

4913 Set of 2 Flags - Only	\$18.00
-----------------------------------	----------------

UPS SHIPPABLE 2 LBS



N 4912



O 6110

Wall rack holds 3-Standard Uprights!

O Volleyball Standard Wall Storage Rack
Steel wall rack anchors to wall and 3-standard uprights with 3" industrial strength Velcro® strapping. Fits all standard makes.

6110	\$120.00
-------------	-----------------



P 4900

Set/Stand
DISASSEMBLES
QUICKLY FOR
COMPACT
STORAGE!

P 4905

P Spike/Set Stand with Ball Rack

Super training aid for spiking & setting. Welded with 1-1/4" steel square tubing. 30"H, ball rack and wheels remove to make a plyo-box. Lightweight and easy to roll to storage. Volleyball rack top removes and folds flat for storage.

4900 Includes #4905 & #4034 168 LBS. FREIGHT ONLY	\$487.00
4905 VB Training Platform - Only 95 LBS. FREIGHT ONLY	\$264.00
4034 Optional Wheel Kit for #4905 (Included with #4900)	\$53.00

UPS SHIPPABLE 6 LBS.

★ CONTINUOUS FLOW ★ DRY-LINE MARKERS ★

A) 25 lb. Galvanized Steel Dry-Line Marker

Internal paddle system ensures a continuous even flow!

Features a 2" or 4" line, adjustable flow from heavy to light. On/off lever on handle to eliminate bending over. Features two 8" wheels.

0822 \$139.00

UPS SHIPPABLE
1@11 LBS., 1@17 LBS.



25 LBS



2" FLOW



4" FLOW

A
0822

B) 50 lb. Galvanized Steel Dry-Line Marker

Internal paddle system ensures a continuous even flow!

Features a 2" or 4" line, adjustable flow from heavy to light. On/off lever on handle to eliminate bending over. Features four 8" wheels.

0817 \$229.00

UPS SHIPPABLE
1@12 LBS., 1@24 LBS.



50 LBS



2" FLOW



4" FLOW

B
0817

C) 50 lb. Dry-Line Marker

Internal paddle system ensures a continuous even flow!

Same features as the #0817 with two 8" wheels.

0821 \$169.00

UPS SHIPPABLE
1@11 LBS., 1@19 LBS.



50 LBS



2" FLOW



4" FLOW

C
0821

D) 100 lb. Dry-Line Marker

Internal paddle system ensures a continuous even flow!

2" -OR- 4" wide line adjustment. Constructed of long lasting galvanized steel. Large capacity limits refilling.

Four 8" wheels for excellent traction on all surfaces. Stainless steel adjustment slide for large or small powder flow. On/off rod near handle eliminates unnecessary bending over.

0819 \$269.00

UPS SHIPPABLE
1@31 LBS., 1@13 LBS.



100 LBS



2" FLOW



4" FLOW

D
0819

E) 100 lb. Complex Dry-Line Marker

Internal paddle system ensures a continuous even flow!

Designed for parks and rec and big complex facilities. 4-10" pneumatic wheels for straight line, easy tracking over rough & muddy fields. Galvanized steel hopper. 2" -OR- 4" wide line adjustment. Same features of the #0819 marker.

0823 \$299.00

UPS SHIPPABLE
1@13 LBS., 1@38 LBS



100 LBS



2" FLOW



4" FLOW

E
0823

Internal paddle system ensures a continuous even flow!

LINE TOUCH UPS & SMALL JOBS!



F
0816

F) 200 Yard Steel Dry-Line Marker

Two 6" wheels and has 2" line. 200 yard capacity. Powder coated. Every school needs this liner for line touch-ups and small jobs.

0816 \$99.00

UPS SHIPPABLE 12 LBS.



G
0842

THREE ADJUSTABLE HEIGHTS

★ GREAT FOR BATTING & PITCHING PRACTICE! ★

G) S.B. Hopper

Great for baseball and softball batting and pitching practice. Three height adjustments 24", 30", 36". Holds 84-baseballs or 60-softballs. Hopper is constructed of 18 oz vinyl with heavy mesh on two sides and bottom. Zinc plated steel base.

0842 UPS SHIPPABLE 18 LBS. **\$99.00**

H) YELLOW ★ 0856, 0858

BLACK ★ 0857, 0859

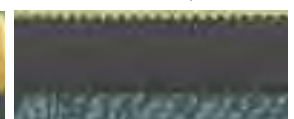

H) Fence Crown™

Safe good-looking fence tops. Bright yellow or black corrugated plastic tubing. 4-1/2" diameter. Pre-slit for easy installation. 19" matching ties. Sold below.

0856 Yellow 100'	27 LBS. FREIGHT ONLY	\$129.00
0857 Black 100'	27 LBS. FREIGHT ONLY	\$129.00
0858 Yellow 250'	67 LBS. FREIGHT ONLY	\$200.00
0859 Black 250'	67 LBS. FREIGHT ONLY	\$200.00

Makes installing a zip-cuts time by 75%!



I) Fence Crown Tool

The installer spreads the fence crown tube and allows the tubing to close over the fence top as you pull the tool forward.

0856T \$68.00
UPS SHIPPABLE 3 LBS.



J) Fence Crown Ties

19" matching ties. 100-per bag.

0860 Yellow 19" Ties	\$39.00 / bag
UPS SHIPPABLE 2 LBS.	
0861 Black 19" Ties	\$39.00 / bag
UPS SHIPPABLE 2 LBS.	

Please contact your dealer for your final price.

BASEBALL ★ SOFTBALL **BLAZER**

BASEBALL & SOFTBALL

★ **SAVE MONEY WHEN YOU PURCHASE THE COMPLETE KIT IN 1-EASY STEP!** ★

K COMPLETE ★ FIELD MAINTENANCE KIT ★

YOUR BEST VALUE!

K COMPLETE ★ FIELD MAINTENANCE KIT INCLUDES:

- #1809 • 1-Sport rake
- #1810 • 1-Loop hoe
- #1797 • 1-Steel ramp
- #1793 • 1-Monster broom

1820 \$384.00

UPS SHIPPABLE 1 @ 10 LBS. + AH, 1 @ 21 LBS. + AH, 1 @ 18 LBS. + AH

ALL 4 IN ONE PACKAGE!



L
084412
084418
0844

M
0843

L Pitchers Mound Weather Cover
Waterproof. 6-oz. woven polyethylene. Colors: Silver/white.
#084412 12' DIAMETER \$74.00
Includes: 5-stakes UPS SHIP 10 LBS.
#084418 18' DIAMETER \$111.00
Includes: 6-stakes UPS SHIP 14 LBS.
#0844 20' DIAMETER \$139.00
Includes: 7-stakes UPS SHIP 19 LBS.

M Home Plate Weather Cover
Waterproof. 26' diameter. 6-oz. woven polyethylene. Includes 9-stakes. Colors: Silver/white.
#0843 \$217.00
UPS SHIPPABLE 30 LBS.



N
0866

N Base Covers
6-oz. woven polyethylene waterproof weather covers for first, second and third base. Colors: Silver/white.
#0866 \$140.00/set
(3)-10' x 10' Base Covers - Includes: 15-stakes
UPS SHIPPABLE 24 LBS.

O Steel Tarp
No more broken handles. Made from a 10" square, 1/4" thick steel plate, welded to a 1-5/8" OD x 42" handle with 4-gussets. Most rugged tarp you will find on the market.
#1797 \$78.00
UPS SHIPPABLE 18 LBS. + AH

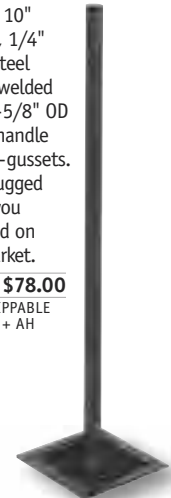

P
0867

P Complete Infield Kit
Waterproof. 6-oz. woven polyethylene. Colors: Silver/white.
#0867 (3)-10' x 10' Base Covers, (1)-20' Pitchers Mound Cover \$499.00/set
(1)-26' Home Plate Cover - Includes: 30-stakes UPS SHIPPABLE 78 LBS.



Q
0850

Q Heavy Duty Stakes
#0850 \$2.10/ea
9" LONG
UPS SHIPPABLE 1 LB.

R Loop Hoe
Double-edged knife rocks back and forth for efficient push and pull motion. 60" x 1-1/8" d. A sturdy blue powder-coated aluminum handle with 6" non-slip vinyl grip.

★ **THE PERFECT TOOL FOR GROOMING INFIELDS!** ★



R
1810

#1810 \$45.00
UPS SHIP 6 LBS. + AH

★ **CUSTOM WIDTHS & LENGTHS AVAILABLE!** ★



S
4945



S
4948

S Baseball/Softball Infield Drag Mat
Complete rust resistant, galvanized finish. Made of 3/8" deep 1" x 1" squares. Includes 1/4" polypropylene pull rope with wooden handle. Rolls up for compact storage.
#4945 6' x 6' \$350.00
UPS SHIPPABLE 63 LBS. + AH
#4948 3'w x 5'L \$197.00
UPS SHIPPABLE 33 LBS.

PROTECTIVE RAIN COVERS
Keep your field dry!

Made from high-strength, long-lasting, reinforced PVC & polyethylene fabrics.

* All covers are cut full size & finish slightly smaller due to seams & hems. Grommets are spaced 3'-4' apart around the perimeter.

★ SAVE MONEY WHEN YOU PURCHASE THE COMPLETE KIT IN 1-EASY STEP! ★

A COMPLETE ★ KICK CAGE PACKAGE

INCLUDES:

- #3014..... • 1-Kicking & punting cage & net
- #2904..... • 1-Kick cage carrying bag
- #3413..... • 1-EZ kick holder

Just add a ball and you're ready to travel!

3015 \$273.00

UPS SHIPPABLE 1@37 LBS. + AH, 1@10

B Kick Cage ★ Kicking & Punting Cage & Net

Heavy walled 1-1/4" galvanized steel frame. Breaks down for easy travel and storage. 78"H x 47"W x 45"D.

3014 \$180.00

UPS SHIPPABLE 35 LBS. + AH

C EZ Kick Holder

Football kicking holder constructed with heavy enameled steel base with flexible rubber tube to hold tip of football at desired position. (Also shown on pg-39.)

3413 \$39.00

UPS SHIPPABLE 5 LBS.

D Kick Cage ★ Carrying Bag

2904 \$60.00

UPS SHIPPABLE 4 LBS.

E Kick Cage ★ Replacement Net

For #3014 Kick Cage.

3016 UPS SHIPPABLE 4 LBS. \$57.00

A COMPLETE ★ KICK CAGE PACKAGE



A 3015 Complete Kick Cage Package

E 3016 Replacement Net

B 3014 Kicking & Punting Cage & Net

C 3413 EZ Kick Holder (Also shown as [N] on page 39)

D 2904 Carrying Bag

F 3410



TRAINER DISASSEMBLES FLAT FOR ★ EASY STORAGE! ★

F Quick Adjust Trainer ★ With Running Ropes

Frame constructed of 1-1/4" galvanized steel 20' long x 5' wide. Nylon web straps with heavy duty shock cord corners that attach to frame. Frame has no cross-members in center that can interfere with running. Adjustable ladder heights from 5" to 15". Disassembles flat for easy storage. Width of squares is 24" x 30" d.

3410 UPS SHIPPABLE 1-BOX, 1@65 LBS. + AH \$200.00

G 3415



G Nylon Replacement Ropes

3415 Ropes only UPS SHIPPABLE 3 LBS. \$80.00

H Knee High Trainers



H Knee High Trainers

Improves balance and agility. Ideal for all sports at all levels. Constructed of structural steel tubing. Completely portable and collapsible by simply pulling 3 pins. 5'w and up to 40' L. A 40' unit stores in an area 16"w, 15' L, and 9"H. Zinc plated tubing. Heavyduty shock cord stretches to prevent injury.

3160 16' ft. L \$274.00

UPS SHIPPABLE 3-BOXES, 1@4 LBS., 1@27 LBS. + AH, 1@20 LBS. + AH

3200 24' ft. L \$340.00

UPS SHIPPABLE 3-BOXES, 1@5 LBS., 1@37 LBS. + AH, 1@29 LBS. + AH

3300 32' ft. L \$500.00

UPS SHIPPABLE 3-BOXES, 1@6 LBS., 1@48 LBS. + AH, 1@39 LBS., + AH

3400 40' ft. L \$609.00

UPS SHIPPABLE 4-BOXES, 1@7 LBS., 1@49 LBS. + AH, 1@32 LBS. + A.H., 1@27 LBS. + A.H.

Trainer ★ Replacement Ropes & Hooks

For knee high trainers.

3165 for 16' Trainer \$55.00

UPS SHIPPABLE 3 LBS.

3222 for 20' Trainer \$65.00

UPS SHIPPABLE 3 LBS.

3225 for 24' Trainer \$71.00

UPS SHIPPABLE 4 LBS.

3333 for 30' Trainer \$89.00

UPS SHIPPABLE 4 LBS.

3335 for 32' Trainer \$92.00

UPS SHIPPABLE 5 LBS.

3445 for 40' Trainer \$106.00

UPS SHIPPABLE 5 LBS.

I 5190



I Football Stat Book

Separate pages for each team's offensive possessions. Handy play number reference column which allows coaches to look up key plays throughout the season. Separate sections for recording kicks, returns, turnovers and penalties. Detailed possession and scoring summary section. Pages for recording post-game team and individual statistics. End of season summary sheets. Additional tear-out pages for recording defensive statistics. Scores 12-games. 78-sheets on 156-pages. 9-1/4" h x 12" w.

5190 \$12.00/ea

Please contact your dealer for your final price.

FOOTBALL PADS ★ RACKS ★ CLEATS **BLAZER**

FOOTBALL

J Save-A-Pad
One fits over #3020 shoulder pad rack upright to support bottom pad from getting flattened. 1-per upright needed.

3021 \$74.00/ea
UPS SHIPPABLE 6 LBS.



★ NO MORE RUINED PADS! ★

CAN TRANSPORT UP TO 100 SHOULDER PADS!

K Shoulder Pad Rack
Rack transports up to 100 shoulder pads. Zinc finished base. 75"H x 59"W at base. Features Four heavy-duty 3" diameter swivel casters for easy mobility. Electroplated galvanized finish. Comes unassembled.

3020 \$267.00
UPS SHIPPABLE 77 LBS. + AH



L 3022D
54-1/2"
TALL

L Display Model
2-Stack Shoulder Pad Rack
54-1/2"H x 21"W x 24"L.

3022D \$158.00
UPS SHIPPABLE 35 LBS. + AH



M 3022
75"
TALL



M 2-Stack Shoulder Pad Rack
Can transport up to 50 shoulder pads, 75"H. This is the answer to your small storage problems.

3022 \$174.00
UPS SHIPPABLE 41 LBS. + AH



N 3413
EZ Kick Holder
(Also shown as C on page 38)

N EZ Kick Holder
Football kicking holder constructed with heavy enameled steel base with flexible rubber tube to hold tip of football at desired position.

3413 \$39.00
UPS SHIPPABLE 5 LBS.

SOCCER CLEATS
★ ON PAGE 23! ★

O Football Cleats
Bags of 100

3520 3/8" Poly* football***	\$12.00
3510 1/2" Poly* football	\$13.00
3530 1/2" Nylon steel FB**	\$15.00
3550 3/4" Poly football	\$17.00

*Polyurethane material is more durable than nylon.**10.40 hardness on the Calvin scale will not burr.***For synthetic turf fields.



P Football Cleats ★ Retail Pkgd 14-Cleats
Poly bagged, properly labeled, and punched for display.

3351 1/2" Poly* football \$2.70/14 pk
3353 1/2" Nylon steel tip football \$3.00/14 pk



Q Football Replacement Cleats ★ Retail Pkgd 14-Cleats

3354CS 1/2" Poly* football with a wrench \$3.60
3358CS 1/2" Nylon steel tip football with a wrench \$3.90

O 3/8"
Poly* Football***
#3520 - Black only



O 1/2"
Poly* Football
#3510 - Black only



O 1/2"
Nylon Steel Tip Football**
#3530 - Black only



O 3/4"
Poly* Football
#3550 - Black only



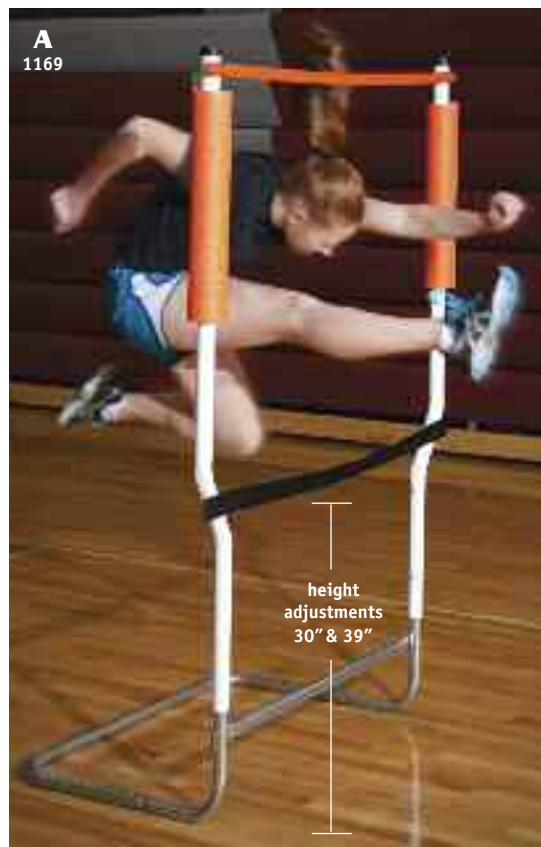

A
1169

A FormFinder, Self Training Device

Training device forces the hurdler into correct body position. Keeps hurdlers arm movement in. Makes hurdler bring trail leg under armpit. Self-training allows coach to spend time with other events. Cloth cross-braces are Velcro® attached which break-away easily upon contact by hurdler. Uprights are powder coated steel.

1169 With Hurdle Base **\$150.00**

UPS SHIPPABLE 2 BOXES - 1 @ 21 LBS., 1 @ 12 LBS.

B Mini Training Hurdles

Essential for teaching recovery mechanics and force application. Athletes learn to “snap” their legs up and down for maximum power output. Linear and lateral drills as well as plyometrics. Great for all sports, improves speed in all directions. Use 12” for linear running mechanics, 6” for lateral and change of direction speed. Hurdles are bright yellow to stand out against any background. Comes with storage bag.

4925 12” - Set of 6 **\$58.00**

UPS SHIPPABLE 6.2 LBS.

4926 6” - Set of 6 **\$57.00**

UPS SHIPPABLE 2.5 LBS.

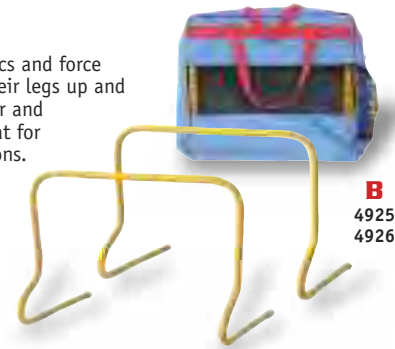

B
4925
4926

**★ IMPROVES SPEED! ★
FOR ALL SPORTS! IN ALL DIRECTIONS!**

C Speed Training Kit

INCLUDES:

- (9) Mini Hurdles . . .
- (3) Each 6”, 9”, 12”H
- (1) 20’ base ladder
- (1) 48” speed chute
- (8) 9” high pro cones
- (8) 2” high marker cones
- (1) Carrying bag

4927 **\$116.00**

UPS SHIPPABLE 19 LBS.



C
4927

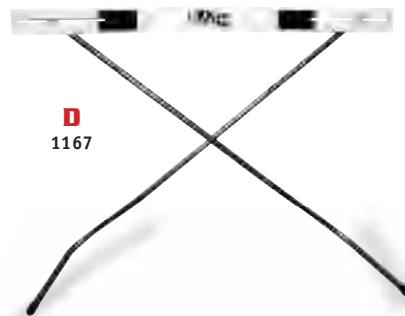

D
1167

D X-Trainer, Collapsible

Quickly adjusts from 16” to 39” high. Great training hurdle for plyometrics, speed, and agility drills. Inexpensive for beginners or a personal hurdle for yourself. Folds flat for easy transport and storage.

1167 **\$40.00**

UPS SHIPPABLE 5 LBS.



E
4006

E Hurdle Sweep™ 3” + Fixture

Hurdle Sweeps™ are a soft brush edge along the top of the hurdle which provide instant technique feedback. The athlete receives tactile and audible feedback - and a coach gets visual and audible information. Interchangeable brush (sweep) provides a 3” edge over the top of the actual hurdle board. The 3” sweep can be used as an actual height when the hurdle is set one notch down. **(Hurdles not included.)**

4006 **\$39.00/ea**

UPS SHIPPABLE 4 LBS.



F
4005



F
4005

**★ PROMOTES ★
“SQUARE AND
CENTER ATTACK!”**

F Hurdle Sweep™ Target Basic Set

Target training sweeps are used for several drills. Use the Target sweeps to give the athlete a specific area to attack each hurdle with a lead leg target, trail leg target or one for each leg. Target Sweeps™ can also be used where you intend the athlete to feel feedback because they should encounter contact with the sweep — or they can be used where you want the athlete to avoid an area of the hurdle (like the inside edge on the curve to prevent hooking) in which case the athlete should not encounter any contact with the Target Sweep. Target Sweeps™ on each side of the hurdle promotes “square and center” attack. Size: 2 x 5”. 2-Fixture attachments. **(Hurdles not included.)**

4005 Set of two UPS SHIPPABLE 3 LBS.

\$39.00/set



G
4020

G Leap Frog

Lead runner and trailing runner take turns providing assisted acceleration. As the trailing athlete runs past the lead runner they exchange roles. The trailing athlete provides resistance to the lead runner. When the resistance cord is maxed out the trailing athlete takes advantage of the resistance to accelerate past the lead runner. 4' Safety Sleeve™ Elastic with 2-swivel belts. Continuously, alternate overspeed, passing, and resistance running. Stretches to 10'.

4020 UPS SHIPPABLE 2 LBS. **\$64.00**



H
4017

H Duo Overspeed Harness

Overspeed training is a fantastic technique to increase speed. 20' safety sleeve elastic will stretch three times its original length to 60'. At 60' with the waist belt end hooked to another runner or an anchored object, this harness will pull you faster than your top running speed, can also be used for many other drills such as leap-frog jumping. Adjustable harness fits small to XXL.

4017 UPS SHIPPABLE 3 LBS. **\$146.00**



I
4014

I Dual Pull

Both athletes run together, back-runner holds back front-runner. Athletes quickly spin around & switch roles going back the other way. 10' long strap with large 3" wide loops at each end.

4014 UPS SHIPPABLE 1 LB. **\$45.00**

**★ FUN & BENEFICIAL! ★
INCREASES SPEED & STRENGTH!**



Safety Sleeve Elastics Protect your athletes, protect yourself. Limits maximum safe stretch distance. If elastic breaks, it will coil inside sleeve preventing injury. Protects elastic from wear from roads, track ... etc. Protects from overexposure to latex material. The product that uses the Safety Sleeve elastic is #4017. (Patent Pending).

**Always inspect resistance cords for wear before every workout and replace at least every 2-years. Goggles are recommended when using resistance cord devices.*

**NEVER stretch cord more than 3-times its length.*



J
4015

Includes nylon carrying bag for compact easy transport.



J Base Ladder

10-high visibility optic yellow adjustable high density flat rungs. Rungs are slotted for easy storage. Comes with heavy-duty nylon carrying bag. 29' in length.

4015 UPS SHIPPABLE 6 LBS **\$48.00**



Stores away neatly in a compact carrying bag.

K
4019

K Adjustable Agility Ladder

Two 15' ladders with 11-adjustable flat slats each. Two ladders can be combined with buckle to make a 30' ladder. Slats are slotted in center to slide on handy carrying handle to store neatly away in carrying bag.

4019 Patent # 224090 UPS SHIPPABLE 8 LBS. **\$69.00**

**★ LESS IMPACT THAN STEEL OR WOODEN BOXES! ★
YOUR ATHLETES WILL NEVER BRUISE THEIR SHINS!**

NO ONE HAS A PLYO BOX LIKE THIS ONE! YOU CAN HAVE THE BEST OF BOTH WORLDS!



NEW!

A Soft Plyo Box
Steel inner frame for strength and stability with a laminated, high density closed cell foam encased in 1000 denier Cordura nylon to prevent slippage.
3-SIZES IN ONE BOX! 20", 24" & 30"!

Call for details on CUSTOM IMPRINTING the cover with your name, mascot or logo!

4041 \$399.00
UPS SHIPPABLE 56 LBS.



B
MEDICINE BALLS

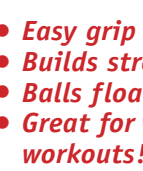
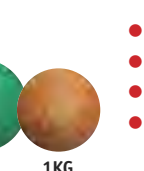
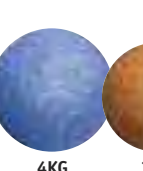
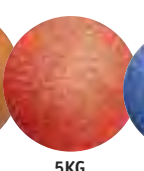
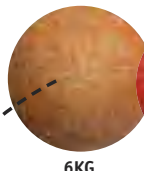

- Easy grip
- Builds strength
- Balls float
- Great for water workouts!

B Medicine Balls

Rubber compound outer shell with textured surface for easy grip. Great training for all sports and works great for an individual workout. These balls float. Great for water workouts. Balls build strength as the torso works to hold its center balance point.

4075	Orange	1kg	2.2 lbs.	★ Dia: 195mm / 07.67"	\$23.00
4076	Green	2kg	4.4 lbs.	★ Dia: 195mm / 07.67"	\$29.00
4077	Orange	3kg	6.6 lbs.	★ Dia: 228mm / 08.97"	41.00
4078	Blue	4kg	8.8 lbs.	★ Dia: 228mm / 08.97"	\$56.00
4079	Red	5kg	11 lbs.	★ Dia: 275mm / 10.82"	\$66.00
4080	Orange	6kg	13.2 lbs.	★ Dia: 275mm / 10.82"	\$65.00
4081	Orange	7kg	15.4 lbs.	★ Dia: 275mm / 10.82"	\$77.00

THESE BALLS ★ BOUNCE! ★



C Quick Explode Sled

For power and explosions this is the one! Comes with 10' strap and adjustable resistance harness (fits small to XXL). Sled constructed of heavy galvanized steel. Will fit standard or olympic plates. (Weights not included.)

4011 UPS SHIPPABLE 38 LBS.

\$205.00

3-SIDED DESIGNED PLYOMETRIC TRAINING BOX
★ STRONG ENOUGH TO HOLD THE BIGGEST ATHLETE! ★

D Plyometric Training Box

Lightweight, strong, sturdy and durable box. Size dimension of 35.5" h x 35.5" h x 30" h Constructed of 1-1/4" welded square steel tubing. Non-marking glides on all 4-legs. Non-slip urethane coated surface supplies cushion and protection as it wraps over the edge of the box. Strong enough to hold the BIGGEST athlete. Wheel kit assembly is available for box. Easily attaches to the legs to make moving of box FAST AND EASY! One side of box is completely open for compact storage, and easily transfers to work-out area.

4039 **\$264.00**

SHIP 61 LBS. FREIGHT ONLY



E Plyometric Training Boxes Wheel Kit

Wheel kit is easily installed and removed. Makes transporting a breeze.

4034 **\$53.00 / pr**

UPS SHIPPABLE 6 LBS.

F
4947

BELT RELEASES CHUTE QUICK & EASILY!

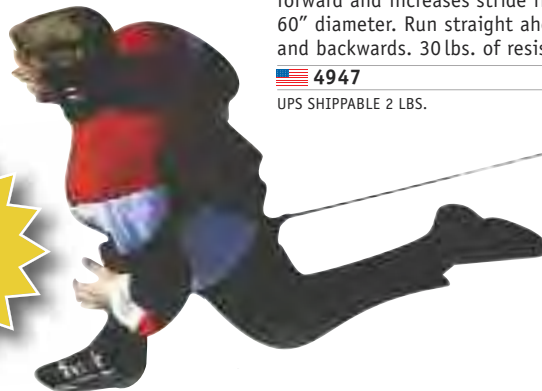

F Windracer Parachute Resistance Trainer

Improves strength, speed, endurance and running form. Velcro belt releases chute quickly so athlete explodes forward and increases stride frequency. Chute has 60" diameter. Run straight ahead, sideways and backwards. 30 lbs. of resistance.

4947 **\$53.00**

UPS SHIPPABLE 2 LBS.

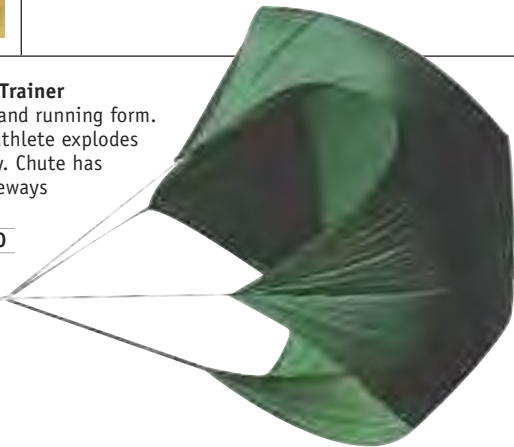

★ IMPROVES STRENGTH ★
★ SPEED & RUNNING FORM! ★

G
4024



G Bullet Belt POP + RIP Release

POP + RIP is a 48" model for starts, turns, resisted runs plus a coach controlled rip cord for smooth transition from resistance to free run when releasing athlete. Best design for developing an explosive track start. *Comes in a red carrying bag!*

4024 UPS SHIPPABLE 3 LBS **\$85.00**

H
4023



★ FOR TRUE EXPLOSIVE TRAINING TECHNIQUES! ★

H Bullet Belt POP Release

POP release is the 15" model for starts, turns and resisted runs. Velcro® break-away for true explosive training techniques.

4023 UPS SHIPPABLE 3 LBS **\$43.00**



Moveable soccer goals can tip over and cause serious injury or death to children who climb on them or hang from crossbar.



BLAZER SOCCER GOALS ARE MADE OF ROUNDED-EDGE TUBING FOR THE ULTIMATE IN SAFETY AND PERFORMANCE.

\$150 FREIGHT

3830 A
Collegiate or HS Goal

3820 B
Junior Goal



A ★ GOALS SOLD WITH NETS ★ B

A Collegiate or High School Goal
8'H x 24'W x 4'D x 8'B. 4" x 4" crossbar and front posts. .125 aluminum wall. 4-anchors for each goal (8-total). Portable or semi-permanent. 2.8 mm thick nets attach with permanently attached "S" hooks. Meets FIFA, NCAA® and NFHS regulations.
3830 Nets - Included \$2,200.00 / pr
480 LBS./PR. 7-BOXES - FREIGHT ONLY

B Junior Goal
6'6"H x 18'6"W x 4'D x 8'B. 4" x 4" crossbar and front posts. .125 aluminum wall. 4-anchors for each goal (8-total). Portable or semi-permanent. 2.8 mm thick nets attach with permanently attached "S" hooks. Meets FIFA regulations.
3820 Anchors & Nets - Included \$1,900.00 / pr
260 LBS./PR GOAL - FREIGHT ONLY

Youth Soccer Goal
6'6"H x 12'W x 2'D x 7'B. 4" x 4" crossbar and front posts. .125 aluminum wall. 4-anchors for each goal (8-total). Portable or semi-permanent. 2.8 mm thick nets attach with permanently attached "S" hooks. Anchors and nets included. Meets FIFA regulations.
3825 FREIGHT ONLY 89 LBS. \$1,900.00 / pr

★ SAVE MONEY! PURCHASE THE COMPLETE PKG IN 1-EASY STEP! ★

C ★ COMPLETE SOCCER GOAL SET PACKAGES ★ D

BEST BUY!
C COMPLETE ★ COLLEGE AND HIGH SCHOOL SOCCER GOAL SET PACKAGE - INCLUDES:
#3830 1-College/HS soccer goal with net/pr
#3883 1-Soccer goal wheel kit/set
3832 \$2,400.00/ set
505 LBS./PR. 8-BOXES - FREIGHT ONLY

BEST BUY!
D COMPLETE ★ JUNIOR SOCCER GOAL SET PACKAGE INCLUDES:
#3820 1-Junior soccer goal with net/pr
#3883 1-Soccer goal wheel kit/set
3822 \$2,100.00/ set
285 LBS./PR. 8-BOXES - FREIGHT ONLY

E Polyethylene White Soccer Nets for Junior Goal
Constructed of white #21 nylon. Includes lacing cords. Size: 6'6"H x 18'6"W x 4'D x 8'B. Sold in pairs.
3821 UPS SHIPPABLE 9 LBS./PR. \$360.00

F Polyethylene White Soccer Nets
Official hex woven netting soccer nets. Size: 8'H x 24'W x 4'D x 8'B. 3mm rope border.
3831 UPS SHIPPABLE 16 LBS./PR. \$165.00

G Polyethylene White Soccer Nets
Constructed of 2.0mm twisted knot soccer net. Size: 8'H x 24'W x 4'D x 10'B. Sold in pairs.
3833 UPS SHIPPABLE 5 LBS./PR. \$117.00

H Soccer Goal Anchor Bags
Perfect for synthetic turf soccer fields.
Black vinyl weight bags. 22" x 14" 18 oz. coated vinyl. Weighs 40 lbs. each when filled with sand (not included). Bag attached with D-ring strap to the back corner base plates of goal.
3827 Set of 2 for 1-Goal \$112.00
UPS SHIPPABLE 4 LBS

I Soccer Goal Wheel Kit
Will fit all Blazer soccer goals only!
10" pneumatic wheel kit makes moving soccer goals a breeze. Easily detachable.
3883 Set of 4 for 1-Field \$240.00
UPS SHIPPABLE 25 LBS.



E 3821 F 3831 G 3833



H 3827



I 3883

★ **TRANSPORT A MULTITUDE OF BALLS** ★
USES VERY LITTLE FLOOR SPACE!

J
4848
4849



J A-Frame Ball Cart
 Strong and durable ball cart!
 1" x 16 gauge round tubing.
 Crosstubes are also zinc plated.
 3" heavy-duty swivel casters.
 Powder coated ends. Some
 assembly required.

- 4848 12-Ball Rack \$140.00**
UPS SHIPPABLE 30 LBS.
- 4849 18-Ball Rack \$155.00**
UPS SHIPPABLE 38 LBS.

★ **5-YEAR WARRANTY!** ★

K
4824



K 24-Ball Rack
 Great idea for P.E. storage.
 Stores and transports up
 to 24 balls at once.
 3" heavy-duty swivel
 casters for easy mobility.
 Powder coated ends.
 40" w x 34-1/2" h x 20-1/2" d.

- 4824 \$189.00**
UPS SHIPPABLE 32 LBS.

★ **STORES UP TO 24 BALLS!** ★

L
4825



L Heavy Duty Ball Cage
 For extra large capacity,
 20-30 balls. Hinged top can
 be padlocked for security.
 Hard rubber casters protect
 gym floor and give easy mobility.
 Frame is made of 1" steel
 tubing. 45" w x 34" h x 23" d.
 All welded steel construction.

- 4825 \$388.00**
UPS SHIPPABLE 78 LBS.

★ **X-TRA LARGE CAPACITY!** ★

M
4826



M Heavy Duty 16-Ball Rack
 Welded construction for strength and durability.
 Steel square tubing, enamel silver paint.
 Heavy duty ball bearing casters. 40 - 3/4" h,
 wheel base is 18" d.

- **4826 STANDARD COLOR: Silver \$280.00**
- **4826 Special Order Color: Red \$300.00**
- **4826 Special Order Color: Royal \$300.00**
- **4826 Special Order Color: Black \$300.00**
- **4826 Special Order Color: White \$300.00**
- **4826 Special Order Color: Forest \$300.00**
- **4826 Special Order Color: Maroon \$300.00**

UPS SHIPPABLE 53 LBS. + AH

★ **HEAVY-DUTY!** ★

N Space Mizer Ball Cage
 Lockable vertical
 steel ball cage.
 Store and transport
 a multitude of balls
 using very little



floor space. Non-marking swivel casters provide
 smooth rolling. Safely stores 28-basketballs or
 32-volleyballs. Can be used for all kinds of balls.
 Medicine, utility, etc. Standard color is red.

- **4827 STANDARD COLOR: Red \$485.00**
- **4827 Special Order Color: Royal \$505.00**
- **4827 Special Order Color: Black \$505.00**
- **4827 Special Order Color: White \$505.00**
- **4827 Special Order Color: Forest \$505.00**
- **4827 Special Order Color: Maroon \$505.00**
- **4827 Special Order Color: Silver \$505.00**

110 LBS. FREIGHT ONLY

N 4827



**★ BLAZER IS THE EXCLUSIVE DISTRIBUTOR OF ★
THE "FAMOUS" BIG RED SCOREBOOKS!
TOTALLY PERSONALIZED FOR THE DEALER! ★ TOTALLY COMPLETE FOR THE COACH!
Blazer is the only choice for all your scorebooks!**

★ BASEBALL / SOFTBALL ★

<p>A Baseball / Softball Detailed Scorebook 12-Player Scores 24-games. Large scoring squares. 12-player, line-up cards. Season summary chart for each player. Batting average charts. <i>Size: 9-1/4" x 12"</i>.</p>  <p>5040 \$5.90</p>	<p>B Baseball / Softball Scorebook ★ 18-Player Scores 24-games. Large scoring squares. Same description as scorebook #5040 except space to list 18-players. Also subs with pitch count. <i>Size: 9-1/4" x 12"</i>.</p>  <p>5085 \$5.90</p>	<p>C Baseball / Softball Detailed Scorebook 12-Player Scores 48-games. Large scoring squares. Same as scorebook #5040 except scores 48-games. <i>Size: 9-1/4" x 12"</i>.</p>  <p>5090 \$8.40</p>	<p>D Baseball / Softball Side-by-Side Scorebook ★ 15-Player Scores 50-games. Score both teams on one page. Pitching count chart. Detailed format. <i>Size: 11" x 14"</i>.</p>  <p>5046 \$13.65</p>
		<p>E Baseball / Softball Enlarged Format Scorebook ★ 12-Player Scores 50-games. <i>Size: 11" x 14"</i>.</p>  <p>5045 \$13.65</p>	

★ TRACK & FIELD ★

<p>F Track Meet Record Cards ★ 18-Teams Master score sheet scores 8-places for 18 teams. 20-individual event cards printed on both sides. Space for time, height, distance of all 6-place finishers. <i>Includes: 4-relay cards and 1-summary sheet. Additional cards are available upon request.</i></p>  <p>5010 \$4.95</p>	<p>G Track Scorebook 19-Meets Scores 14 individual events and 3-relays. Up to 8-places can be scored. Time, height, distance can be recorded in all places. Can be used for any size meet. <i>Size: 9-1/4" x 12"</i>.</p>  <p>5110 \$6.60</p>
--	--

★ VOLLEYBALL ★

<p>H Volleyball ★ 23-Matches Rally scoring. Notation for Libero player. Scores up to 36-pts. Season summary and statistics. Scores high school or college. Follows National Federation scoring procedure. Cumulative charts, season's summary and statistics page. Scores 23 matches with spaces for 18-substitutions. Wire-bound. Line-up cards. Includes a section for comments. Updated scoring rules & substitutions. <i>Size: 9-1/4" x 12"</i>.</p>  <p>5020 \$5.90</p>	<p>I Volleyball 36-Matches Same as #5020, except with 36-matches.</p>  <p>5026 \$8.40</p>
---	--

★ FOOTBALL ★

J Football Stat Book ★ 12-Games
78-sheets on 156-pages. Separate pages for each team's offensive possessions. Handy play number reference column which allows coaches to look up key plays throughout the season. Separate sections for recording kicks, returns, turnovers and penalties. Detailed possession and scoring summary section. Pages for recording post-game team and individual statistics. End of season summary sheets. Additional tear-out pages for recording defensive statistics. *Size: 9-1/4" x 12"*.



5190 \$12.00

★ BASKETBALL ★

<p>K Basketball Scorebook 30-Games Space to list 15-players. Running score includes space for number of individual scoring. Cumulative charts for the entire season. Season schedule and results. Wire-bound. Alternate possession chart & 3 pt. scoring. <i>Size: 9-1/4" x 12"</i>.</p>  <p>5030 \$5.90</p>	<p>L Basketball Scorebook 20-Players Scores 26 games. Same as the #5030 book. Season schedule results. <i>Size: 9-1/4" x 12"</i>.</p>  <p>5035 \$6.60</p>
---	--



Please contact your dealer for your final price.

SCOREBOOKS ★ LINE-UP CARDS 

SCOREBOOKS & LINE-UP CARDS

★ CUSTOM PRINT PROGRAMS ARE AVAILABLE ★
CUSTOMIZE ALL YOUR SCOREBOOKS!

CUSTOMIZE WITH YOUR LOGO! ★ EASY ORDERING! ★ EASY FILL-INS!

Contact your representative for complete details.

★ SOCCER ★

**M Soccer Scorebook
24-Matches**

Charts for listing schedule and squad members. Running score, goalie save and assist sections. Space for detailed offensive & defensive record keeping. Heavy back cover provides rigid writing surface. *Size: 9-1/4" x 12".*



 **5060** **\$6.60**

★ LACROSSE ★

**N Lacrosse Scorebook ★ Men's
24-Games**

Roster spaces to list 33-players. Scoring space to list 26-players plus 2-goalies. Separate sections for recording penalties, face-offs, man up/man down, goalie saves and running score. Line-up cards and season summary sheets. *Size: 9-1/4" x 12".*



 **5155** **\$6.60**

**O Lacrosse Scorebook ★ Women's
24-Games**

Roster spaces to list 33-players. Scoring spaces to list 26-players plus 2-goalies. Separate sections for recording penalties, free position shot, draws, and shots on goal, goalie saves and running score. Line-up cards and season summary sheets. *Size: 9-1/4" x 12".*

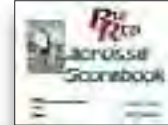

 **5150** **\$6.60**

★ TENNIS ★

**P Tennis Scorebook
24-Matches**

Both singles and doubles. Season schedule and results. Scoring record. Player analysis charts. Court diagram to show shot position, strategies, etc. Season summary for each individual. 16 and 32-tournament bracket forms, perforated. *Size: 9-1/4" x 12".*



 **5130** **\$6.60**

MULTI-SPORT ★ LINE-UP CARDS

**Q Multi-Sport Line-Up
Card Book ★ 24-Games**

18-player line up. A book of 4-part carbonless forms. Line-up cards with hard tag in back. *Size: 9-1/4" x 12".*



 **5280** **\$6.90**

**R Multi-Sport Line-Up
Cards ★ 1-Dozen**

4-part NCR poly bagged. *Size: 6-3/4" x 4-3/8".*



 **5230** **\$3.10**

**S Multi-Sport Line-up
Cards ★ 144-Piece Bulk Brick**

15-player line up multi-sport cards. Sub changes. 4-part NCR paper. Great for baseball, basketball, softball, and other sports. *Size: 6-3/4" x 4-3/8".*



 **5235** **\$33.00**

MULTI-SPORT ★ LINE-UP CARDS

**T Multi-Sport
Line-Up Card Holder**



Cards not included.
 **5291** **\$6.10**

**U Multi-Sport Line-Up Card
Holder ★ With 1-Dozen Cards**



Holder with 1-dozen multi-sport line-up cards.
 **5290** **\$6.90**

VOLLEYBALL ★ LINE-UP CARDS

**V Volleyball Line-Up
Cards ★ 1-Dozen**

Poly bagged. *Size: 6-3/4" x 4-3/8".*

 **5222** **\$3.10**



**W Volleyball Line-Up
Cards ★ 144-Piece Bulk Brick**

2-part NCR paper. *Size: 6-3/4" x 4-3/8".*

 **5221** **\$33.00**

**X Volleyball Line-Up Card
Holder ★ With 1-Dozen Cards**



 **5292** **\$6.90**

